

**DAISY WI-FI : WI-FI INTERFACE, APP-PROGRAMMABLE, TO REMOTELY RADIO CONTROL ALL TELECO DEVICES FROM SMARTPHONES.**

Product code:

# TVDAYxxxA01

## Features

- Available in both 868.3MHz and 916MHz frequencies.
- Easy access via Wi-Fi or mobile network from any compatible device.
- Up to 50 programmable device commands.
- Possibility to create scenarios.
- Weekly timer to send commands at a specific date and time.



**DAISY APP**

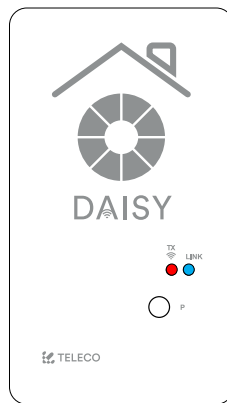

868.3MHz  
916MHz



868.3MHz  
916MHz \*

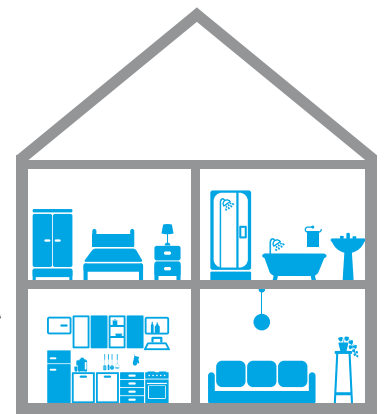

\* The Blue Series receivers are bidirectional. They can receive and execute commands and send the status back to DAISY

## 1.0 CHARACTERISTICS

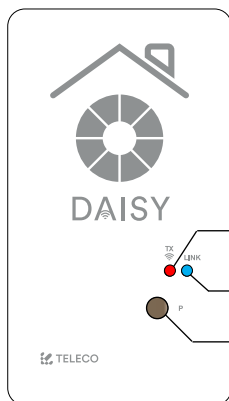

- LED:** Radio commands Transmission
- LED:** Wi-Fi Network
- Button:** Reset Wi-Fi Network configuration (\*)

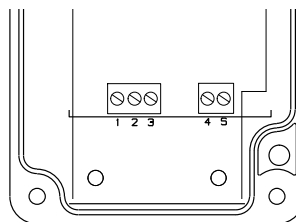

1. +12 ÷ 24Vdc
2. GND (-)
3. +5Vdc
4. COMMON
5. N.O. CONTACT INPUT

**Thermoplastic ABS**  
Not suitable for direct UV exposure

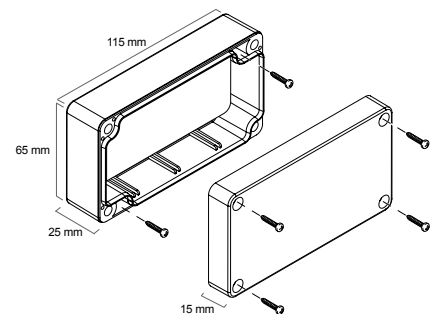

The product guarantees **IP54** rating if properly assembled.

\* The memorized transmitters are not deleted.

## 1.1 TECHNICAL SPECIFICATION

- Transmission frequency	868.3 MHz (TVDAY868A01) 916MHz (TVDAY916A01)	- Max. possible virtual transmitters	50
- Power supply	5 / 12 ÷ 24Vdc	- Protection	IP54
- Operating temperature range	-20° ÷ +50°C	- Material of the box and its cover	Thermoplastic ABS
		- Network Wi-Fi module	802.11 b/g/n
		- Frequency band	2.4GHz

TVDAYXXXA01

DOC.: T799.01\_EN

DATE: 18/02/19

## 2.0 INSTALLATION

Download the app DAISY from App Store or Google Play. Check the compatibility with your device first. Once downloaded, it is possible to use it in DEMO mode, even without any DAISY paired.



In order to connect Daisy to the WiFi network the router doesn't have filter blocks. In case of connection issues please contact the system administrator.

## 3.0 REGISTRATION

The smartphone must be connected to an internet network. Follow the procedure here below described:



1. Tap on "Create new account".



2. Fill the fields with the information required.



3. Once filled the fields tap on "Sign In".

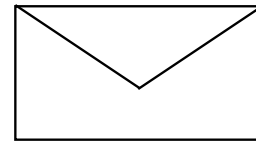

4. Check email to confirm registration.



5. "Log In" with User and PWD assigned.

## 4.0 FIRST CONFIGURATION WITH ANDROID DEVICE

**Mandatory: Android version 4.4 KitKat or later.**



1. Run the Daisy APP



2. Fill the field with the **Code** written on the Daisy box label

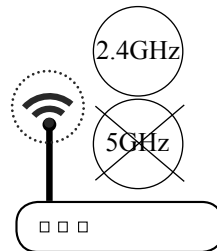

**Name:** Orange\_WiFi\_Network  
**Password:** 12345678

3. Take note of WiFi **Name** and **Password**.



4. Select your WiFi network.



5. Enter Home Network's Password and tap "Continue"

**Warning: Verify that the option to connect to networks without Internet access is enabled in the phone.**

## 4.1 FIRST CONFIGURATION WITH IOS DEVICE

**Mandatory: IOS version 12.0 or later.**



1. On your phone, set up the Daisy\_4C55xx WiFi network and run the Daisy App.



2. Tap on "Create first Installation".

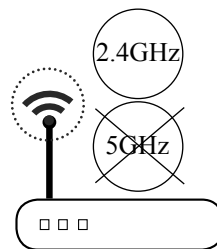

**Name:** Orange\_WiFi\_Network  
**Password:** 12345678

3. Take note of WiFi **Name** and **Password**.



4. Select your WiFi network.



5. Enter Home Network's Password and tap "Continue"

## 5.0 LED INDICATIONS

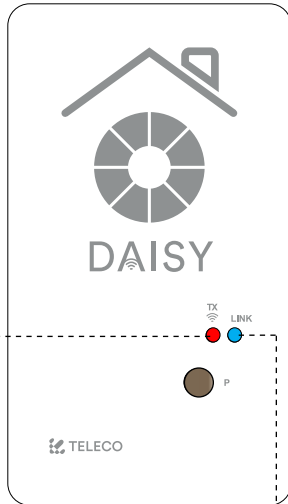

**RED LED:** Radio commands Transmission.

**BLUE LED:** Wi-Fi Network.

Transmission	<b>TX (RED LED): Radio commands</b>
<b>Active</b>	<b>ON</b>
<b>Not Active</b>	<b>OFF</b>
Status Wi-Fi connection	<b>LINK: Wi-Fi Network</b>
<b>Waiting for connection</b>	<b>Blue</b> <b>Blue</b> <b>Blue</b> ... 1 s 1 s
<b>Connecting</b>	<b>Blue</b> <b>Red</b> <b>Blue</b> <b>Red</b> <b>Blue</b> <b>Red</b> ... 0.5 s 0.5 s 0.5 s
<b>Connecting</b>	<b>Blue</b> <b>Blue</b> <b>Blue</b> ... 0.5 s 0.5 s
<b>Connected</b>	<b>Blue</b> <b>ON</b>

## 6.0 MAIN MENU

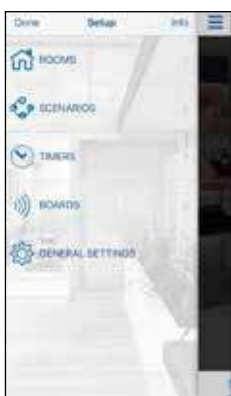

- Direct connection through WiFi router
- Cloud connection
- No connection (Board not reachable)

Tabbar: Home - Scenarios - Favorites

## 6.1 SETUP ROOMS



1. Create new rooms accessing the menu "Rooms" in Setup.



2. Tap (+) to add a room.



3. Tap (Room) to enter in the next menu.

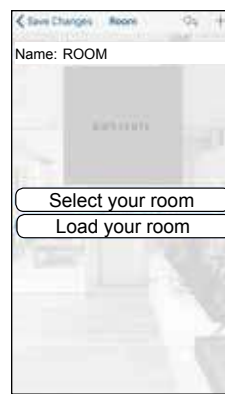

4. Set the name and assign a picture amongst the 6 provided (Select your room) or select a picture of your device gallery.

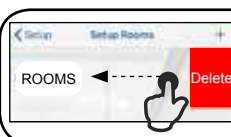

**Note:** swipe a listed room left to delete it.

## 6.2 ADDING COMMANDS TO A ROOM

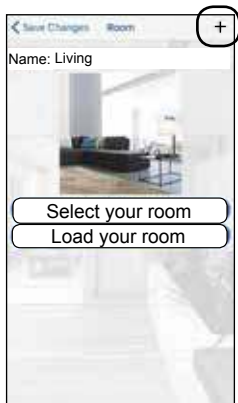

1. Tap "+" to add remote commands. Select the type of controlled device from the list.



2. Tap the transmitter to add.

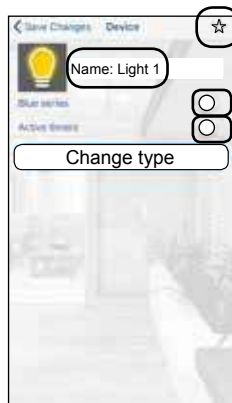

3. Assign a "Name".

----- Add to Favourites

----- Enable if the receiver is Blue Series

----- Enable to set the timers

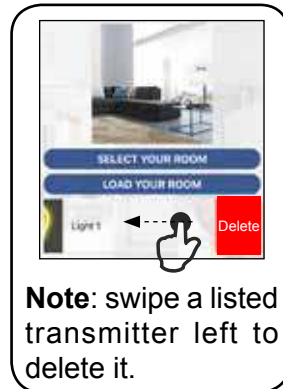

**Note:** swipe a listed transmitter left to delete it.

## 7.0 SCENARIOS



1. Create new scenarios accessing the menu "Scenarios" in Setup.



2. Tap "+" to add a scenario. Set the Name and assign an icon amongst the 9 provided.

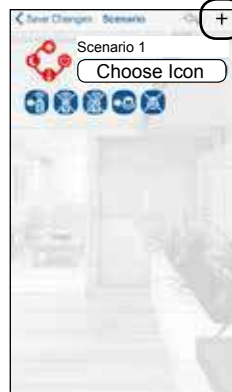

3. Tap "+" to add remote commands from any room.

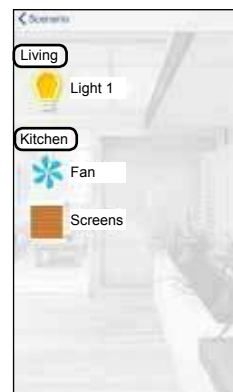

4. Select the type of controlled device from the list.



5. Tap (Light 1) to add the first command.



6. Tap (ON) to choose the command.



7. The first device configured for the scenario appears on the display.



8. Repeat steps 3-4-5 to add the other devices to the scenario.

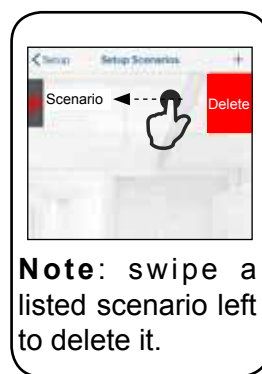

**Note:** swipe a listed scenario left to delete it.

## 7.1 ADVANCED SCENARIO PROGRAMMING

Once the scenario has been completed, it's possible to assign it to a transmitter button or to a wired N.O. button connected to the input 4-5.



Not used

Tap to delete all the associated transmitter buttons.

Tap and press the transmitter button to delete.

Tap and press the transmitter button to assign.

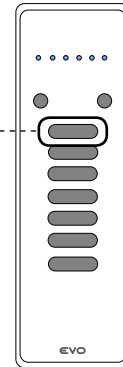

**Note:** When transmitters or the wired input are programmed, these icons are ON

## 8.0 TIMERS

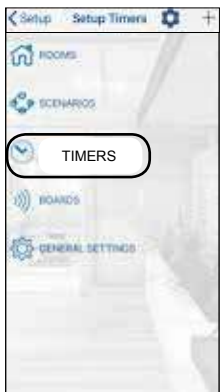

1. Create new timer accessing the menu "Timers" in Setup.



2. Tap "+" to add a timer.

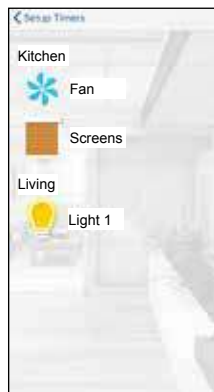

3. Tap "Light 1" to add a timer.



4. Tap (ON) to chose the command.



5. Enable the timers. Set the hour for the timers.



6. Tap "Save Changes".



7. Repeat steps 2 and 3 to add timers to the other devices.



**Note:** swipe a listed timer left to delete it.

**Note:** To operate the timers must be enabled following the procedure described below:



1. Tap gear icon.

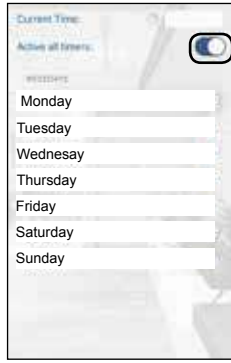

2. Tap (Active all timers) to enable the timers.

Enable timers

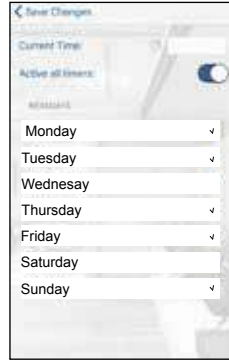

3. It's possible to set weekdays-weekend group. Tap on the day names to add in weekdays groups.

## 9.0 SELECT BOARDS

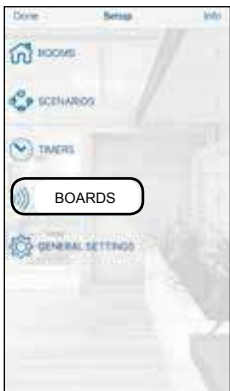

1. Tap (Boards) to enter in the next menu.



2. Tap the chosen board. To add new board tap (+).

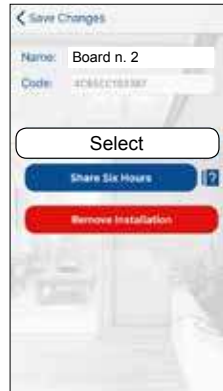

3. To pair the board tap (Select).

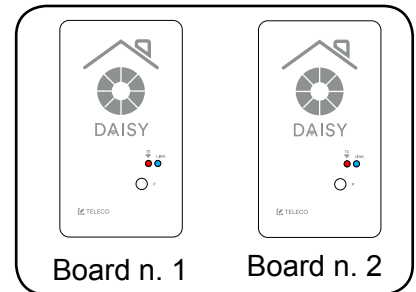

## 11.0 SHARE INSTALLATION (SIX HOURS)

**Note:** Before starting, it is necessary to carry out the **Registration** procedure on the new smartphone described in the paragraph 3.0



### Configured smartphone

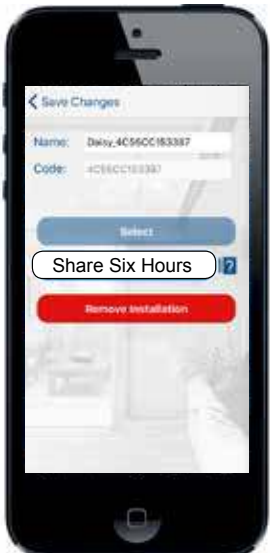

1. Tap (Share installation).

### Configured smartphone



2. Fill the field with the email of the new smartphone. Tap (Share ...) installation.

### New smartphone



3. Accept the invite to share the installation.

## 12.0 GENERAL SETTING



1. Tap (General Setting) to enter in the next menu.

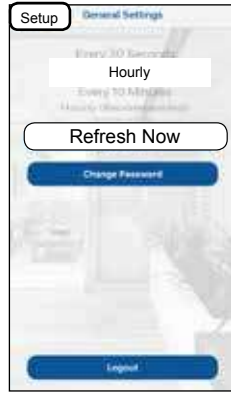

2. Choose the Refresh time and tap (Setup). In alternative tap (Refresh Now).

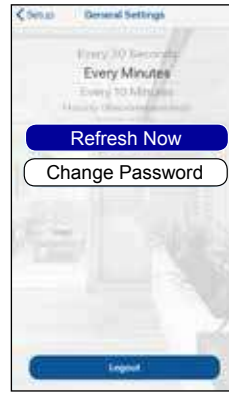

3. In order to set a new password tap (Change Password).

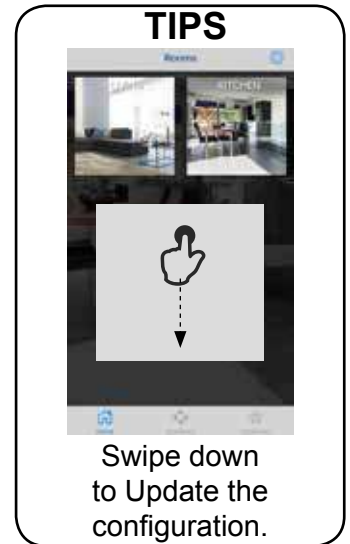

## 13.0 INFO PAGE



1. Tap (Info) to enter in the next menu.



General configuration information

Status information of Daisy board

Software and firmware information

## 14.0 HOME PAGE

Once configured the rooms with the transmitters tap (done) to enter in the (Home) page.



Setup Menu

Rooms set

Favourites transmitters set

Scenario set

## 14.1 DAISY TRANSMITTER

**Note:** To operate the **Daisy transmitters** must be memorized in the receivers. See par. 14.2 and par. 14.3

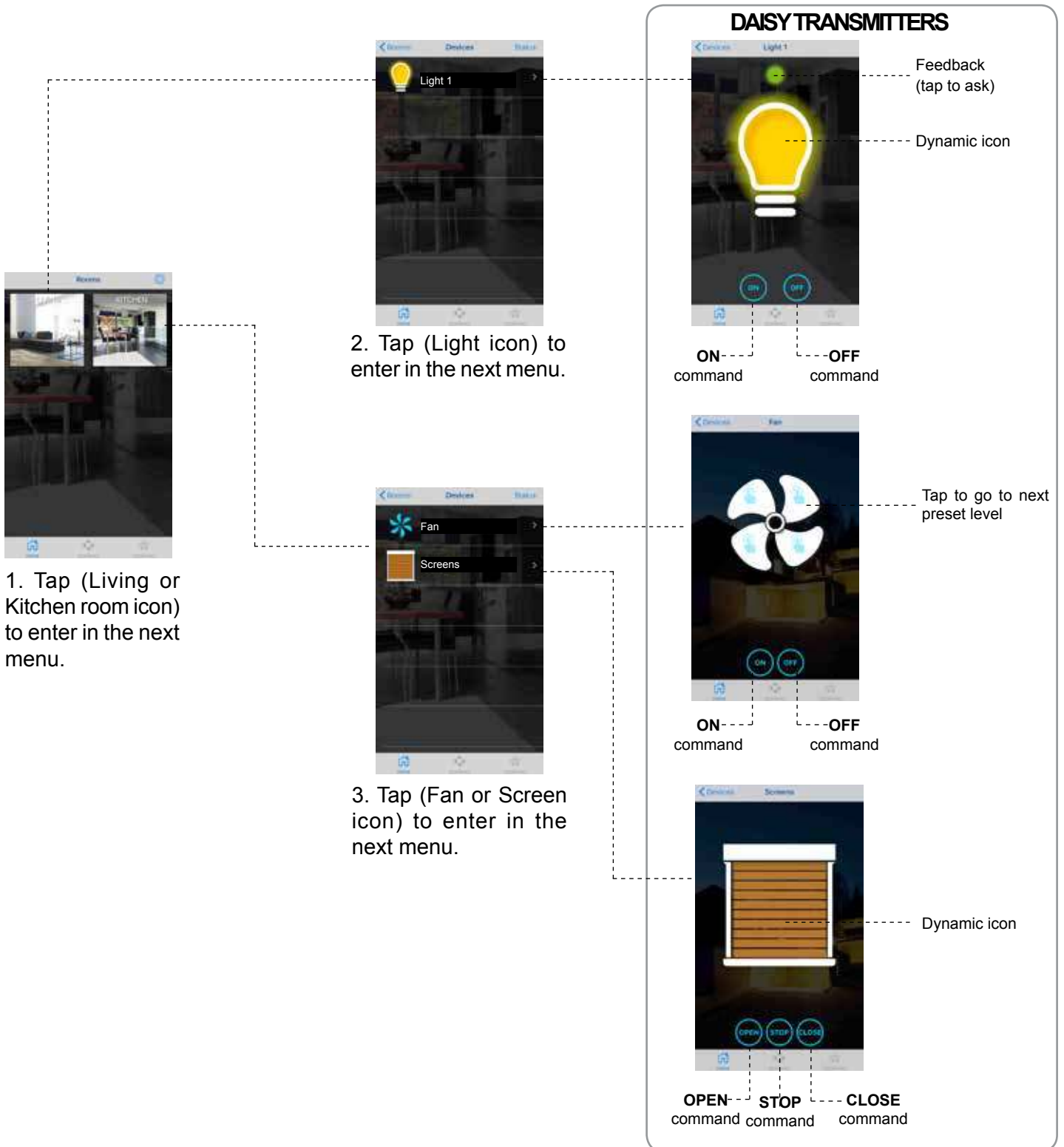

## 14.2 MEMORIZATION



For its proper functioning the Daisy transmitter must be memorized in the controlled receiver. Refer to instruction manual of the receiver for the procedure of memorization.



### 14.3 REMOTE MEMORIZATION OF OTHER RADIO CODES FROM STANDARD TRANSMITTER

**Note:** The button P3 is located inside the standard transmitter. The added radio code will have the same functions as the code used for memorization. This procedure is compatible with any type of transmitter.

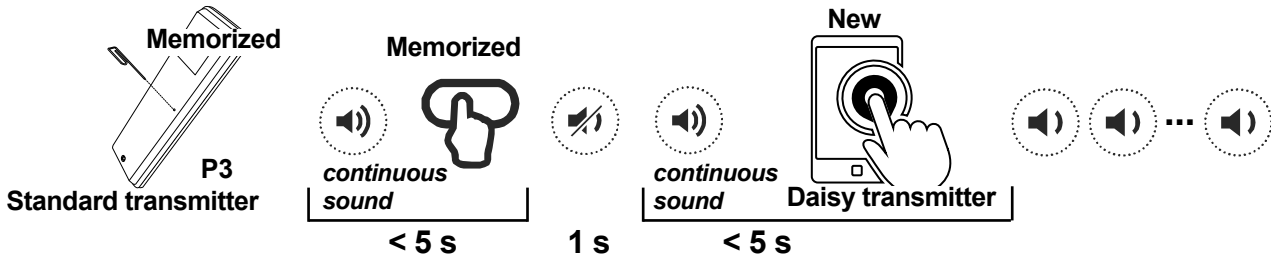

Press button **P3** of the **memorized** standard transmitter and hold. The buzzer emits a continuous sound. Press a button relative to an **already memorized** code. The buzzer stops for 1 second and then starts the continuous sound again. Press the virtual button on the Daisy transmitter relative to the **new** code to be memorized. Successful memorization is indicated by the intermittent sound of the buzzer.

### 15.0 SENDING SCENARIO



1. Tap (Scenario icon) to enter in the next menu.



2. Tap (Scenario icon) to send scenario.



3. Tap (Yes) to send scenario.

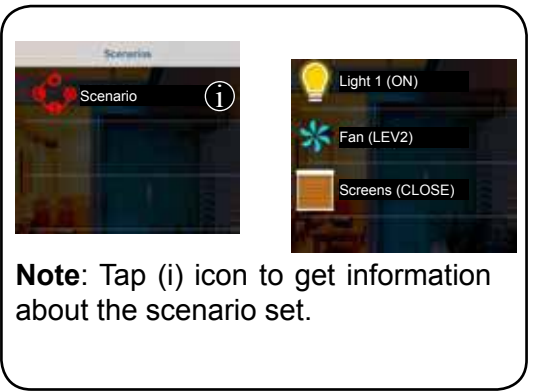

**Note:** Tap (i) icon to get information about the scenario set.

### 16.0 RESET WI-FI NETWORK CONFIGURATION

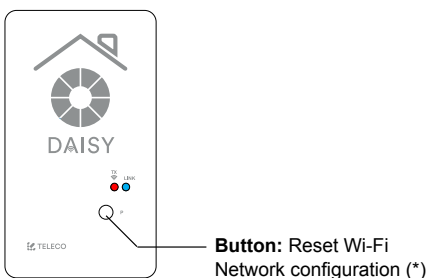

\* The memorized transmitters are not deleted.

Press **(P)** once and hold for **5s**:

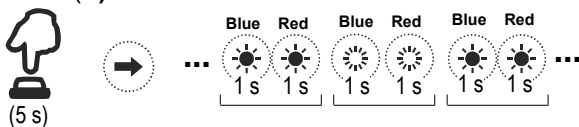

Alternatively **hold the button (P) down** and at the same time **turn on the power**:

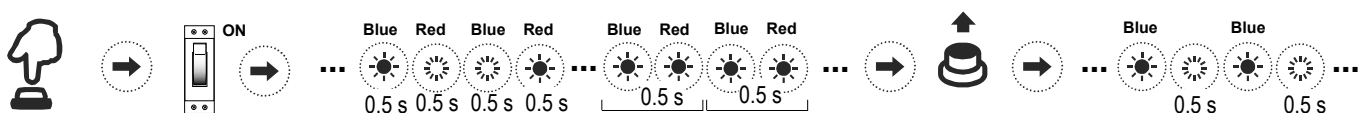

## 17.0 TROUBLESHOOTING (WHAT TO DO IF...)

Problem	Solution
<p><i>First configuration procedure:</i> Blue and Red LEDs flashes alternately for long time</p>	<p>Wait until the LEDs stop flashing even if appear the message "Connection between board and phone failed". If the LEDs continue to flash, check that the router does not have filters blocks set.</p>
<p><i>First configuration procedure:</i> Blue Led flashes slowly - Connection failed</p>	<p>Check that the data are correct and repeat the first installation procedure.</p>
<p><i>First configuration procedure:</i> GPS connection problem</p>	<p>Verify that the GPS function is enabled and set to high precision mode</p>
<p><i>Normal operating mode:</i> Disconnection from the WiFi network: Blue and Red LEDs flashes alternately</p>	<p>Verify that the router is powered and connected to internet.</p>
<p><i>Normal operating mode:</i> No internet connection - Blue LED flashes each 0.3s.</p>	<p>Check the router's internet connection</p>
<p><i>Normal operating mode:</i> Emergency mode - Blue LED flashes each 0.1s.</p>	<p>Available only direct commands. Check the router's internet connection</p>



**DAISY APP**

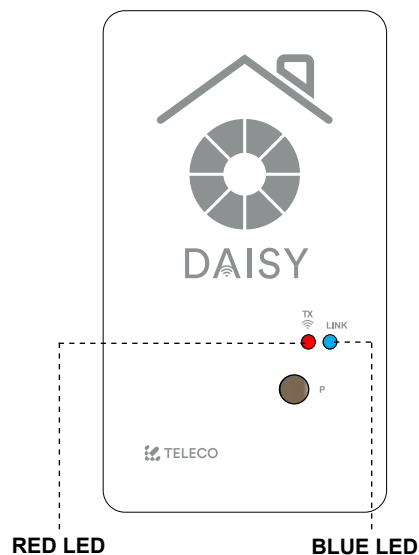



**IMPORTANT! READ CAREFULLY THESE INSTRUCTIONS BEFORE INSTALLING AND COMMISSIONING THE PRODUCT. SAVE THESE INSTRUCTIONS FOR FUTURE REFERENCE.**

**PRODUCT INSTALLATION:** The product at issue must be installed, commissioned and maintained only by licensed and authorised people, respecting the laws concerning the electrical installations. The manufacturer is not responsible for any damage due to wrong installation or improper use.

**SAFETY INFORMATION:** The radio signal reception of the device could be disturbed by the presence of electrical disturbances being transmitted by other appliances working on the same frequency or if the product is somehow shielded by metal parts.

The manufacturer, Teleco Automation s.r.l, declares that the type of radio equipment is compliant with Directive 2014/53/EU. The full text of the EU compliance declaration is available at the following Internet address: [www.telecoautomation.com/ce](http://www.telecoautomation.com/ce).

**In the view of a constant development of their products, the manufacturer reserves the right for changing technical data and features without prior notice.**

**INFORMATION TO USERS** under art. 14 of the 2012/19/EU DIRECTIVE OF THE EUROPEAN PARLIAMENT AND COUNCIL of 4 July 2012 on waste electrical and electronic equipment (WEEE). The crossed bin symbol on the equipment, or its packaging, indicates that the product must be collected separately from other waste at the end of its useful life and not with mixed urban waste. Please contact your municipality, or local authority, for all information regarding the waste sorting systems available in the area. The retailer is obliged to collect the old equipment free-of-charge when the customer buys a new equivalent equipment. This is to encourage correct recycling/disposal. Appropriate waste sorting for the subsequent recycling, treatment and disposal in an environmentally sound way of the disused equipment avoids negative effects on the environment or human health and favours the re-use or recycling of the equipment's materials.



**TELECO AUTOMATION S.R.L.**

**ITALY**  
Tel. +39.0438.388511  
info@telecoautomation.com

**TELECO AUTOMATION FRANCE**

**FRANCE**  
Tel. +33.(0)472.145080  
info@telecofrance.com

**TELECO AUTOMATION GMBH**

**GERMANY**  
Tel. +49.(0)8122.9563024  
info.de@telecoautomation.com

**TELECO AUTOMATION OCEANIA PTY LTD**

**AUSTRALIA**  
Tel. +61.(07)5502.7801  
info@telecoautomation.com.au

**DAISY WI-FI : INTERFACCIA WI-FI, PROGRAMMABILE DA APP, PER CONTROLLARE VIA RADIO TUTTI I DISPOSITIVI TELECO A DISTANZA CON SMARTPHONE**

Codice prodotto:

# TVDAYxxxA01

## Caratteristiche

- Disponibile in entrambe le frequenze 868.3MHz e 916MHz.
- Facile accesso via Wi-Fi o rete mobile da ogni dispositivo compatibile.
- Fino a 50 trasmettitori memorizzabili.
- Possibilità di creare scenari.
- Timer settimanali per inviare comandi ad una specifica data ed ora.



**DAISY APP**



Wi-Fi

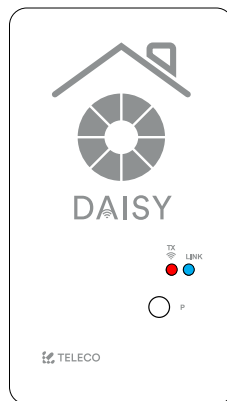

868.3MHz  
916MHz



868.3MHz  
916MHz \*

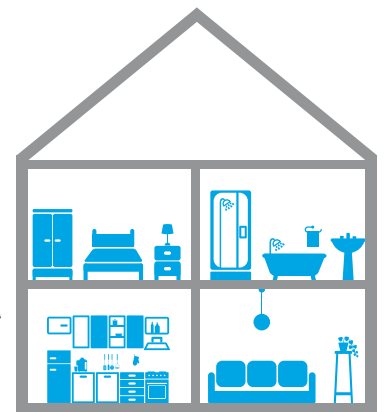

\* I ricevitori Blue Series sono bidirezionali. Possono ricevere ed eseguire comandi ritornando lo stato a DAISY

## 1.0 CARATTERISTICHE

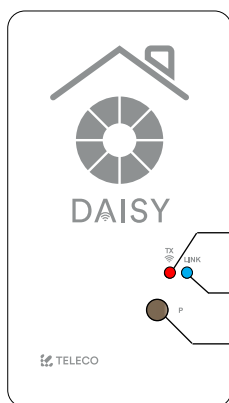

**LED:** Trasmissione comandi radio

**LED:** Rete Wi-Fi

**Pulsante:** Reset delle impostazioni della rete Wi-Fi (\*)

\* I telecomandi memorizzati non vengono cancellati.

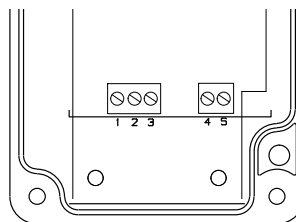

1. +12 ÷ 24Vcc
2. GND (-)
3. +5Vcc
4. COMUNE
5. CONTATTO N.A.

### TERMOPLASTICA ABS

Non adatta ad una esposizione diretta ai raggi UV

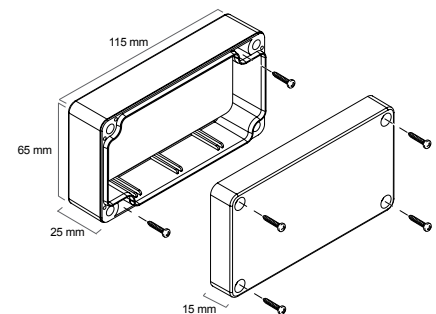

Il prodotto garantisce un grado di protezione **IP54** se correttamente assemblato

## 1.1 SPECIFICHE TECNICHE

- Frequenza di trasmissione	868.3 MHz (TVDAY868A01) 916MHz (TVDAY916A01)	- Capacità memoria radio (trasmettitori)	50
- Alimentazione	5 / 12 ÷ 24Vdc	- Grado di protezione	IP54
- Temperatura di funzionamento	-20° ÷ +50°C	- Materiale scatola e coperchio	Termoplastica ABS
		- Modulo rete WiFi	802.11 b/g/n
		- Banda di frequenza	2.4GHz

TVDAYXXXA01

DOC.: T799.01\_IT

DATE: 18/02/19

## 2.0 INSTALLAZIONE

Eseguire il download della DAISY APP da App Store o Google Play. Verificare prima la compatibilità con il proprio dispositivo. Una volta installata, è possibile utilizzarla in modalità DEMO, anche senza aver eseguito nessuna memorizzazione.



⚠ Per collegare Daisy alla rete WiFi il router non deve avere dei blocchi di filtro impostati. In caso di problemi di connessione contattare il proprio amministratore di sistema.

## 3.0 REGISTRAZIONE

Lo smartphone deve essere collegato ad una rete internet. Seguire la procedura descritta di seguito:



1. Premere "Create new account".



2. Compilare i campi con le informazioni richieste.



3. Una volta compilati i campi premere "Sign In".

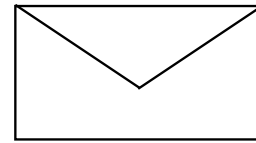

4. Controllare la posta per confermare la registrazione



5. "Log In" utilizzando la User e PWD assegnate

## 4.0 PRIMA CONFIGURAZIONE CON DISPOSITIVI ANDROID

**Requisito: Versione Android 4.4 KitKat o successive.**



1. Avviare la APP Daisy



2. Compilare il campo con il codice riportato sull'etichetta.

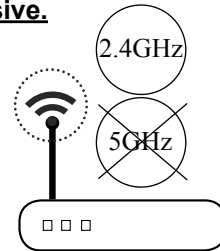

**Nome:** Orange\_WiFi\_Network  
**Password:** 12345678

3. Prendere nota del **Nome** della rete WiFi e della **Password**.



4. Selezionare la propria rete WiFi.

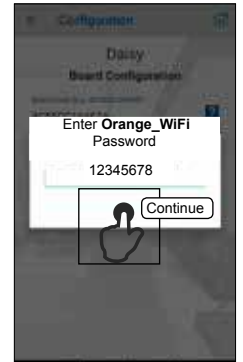

5. Inserire la Password della rete e premere "Continue".

**Attenzione: Verificare che lo smartphone abbia abilitata l'opzione di collegamento alle reti WiFi senza accesso ad internet.**

## 4.1 PRIMA CONFIGURAZIONE CON DISPOSITIVI IOS

**Requisito: Versione IOS 12.0 o successive**



1. Collegare lo smartphone alla rete WiFi Daisy\_4C55xx ed avviare la Daisy APP.



2. Premere "Create first Installation".

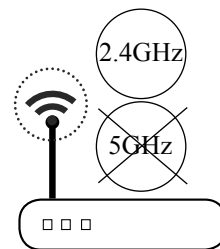

**Name:** Orange\_WiFi\_Network  
**Password:** 12345678

3. Prendere nota del **Nome** e della **Password** della rete WIFI.



4. Selezionare la propria rete WiFi.

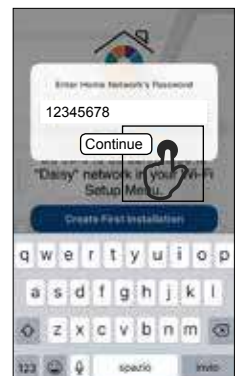

5. Inserire la Password della rete e premere "Continue".

## 5.0 SEGNALAZIONI LED

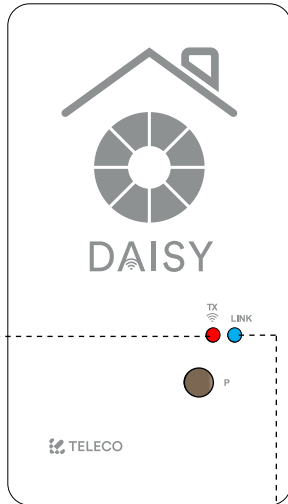

**LED ROSSO:**Trasmissione comandi Radio.

**LED BLU:** Rete Wi-Fi

Trasmissione	<b>TX (LED ROSSO): Comandi radio</b>
<b>Attiva</b>	<b>ON</b>
<b>Non attiva</b>	<b>OFF</b>
Stato connessione Wi-Fi	<b>LINK: Rete Wi-Fi</b>
<b>In attesa di connessione</b>	<b>Blu</b> <b>1 s</b> <b>1 s</b> <b>1 s</b> <b>...</b>
<b>In fase di connessione</b>	<b>Blu Rosso Blu Rosso Blu Rosso</b>  0.5 s 0.5 s 0.5 s <b>...</b>
<b>In fase di connessione</b>	<b>Blu</b> <b>0.5 s</b> <b>0.5 s</b> <b>0.5 s</b> <b>...</b>
<b>Connesso</b>	<b>Blu</b> <b>ON</b>

## 6.0 MENU PRINCIPALE



- Collegamento diretto attraverso router WiFi
- Collegamento via Cloud
- Nessun collegamento (Scheda non raggiungibile)

Tabbar: Home - Scenari - Favoriti

## 6.1 CREAZIONE DELLE STANZE

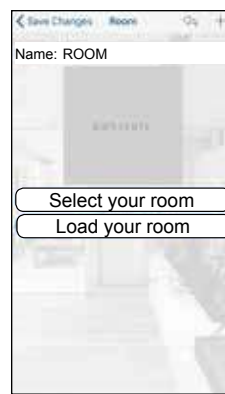

1. Creare nuove stanze selezionando "Rooms" nella pagina "Setup".

2. Premere (+) per aggiungere una stanza.

3. Premere (Room) per accedere al menu successivo.

4. Scrivere il nome e assegnare un'immagine tra le sei proposte (Select your room) oppure selezionarne una dalla galleria immagini del dispositivo (Load your room).

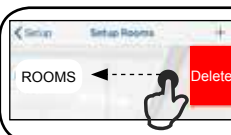

**Nota:** Scorrere verso sinistra la voce per eliminarla dalla lista.

## 6.2 AGGIUNGERE TRASMETTITORI ALLA STANZA

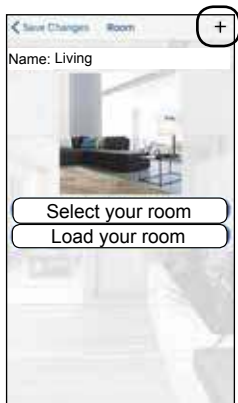

1. Premere “+” per aggiungere dei trasmettitori. Scegliere la tipologia del dispositivo controllato dalla lista che compare.



2. Scegliere il trasmettitore da aggiungere.

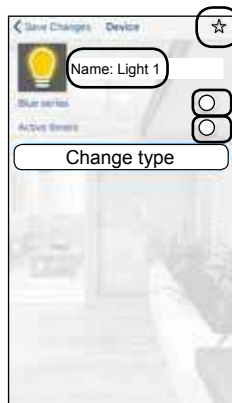

3. Assegnare un “Nome”.

----- Aggiungere a preferiti

----- Abilitare se il ricevitore è Blue Series

----- Abilitare per impostare i timers.



**Nota:** Scorrere verso sinistra la voce per eliminarla dalla lista.

## 7.0 SCENARI



1. Creare un nuovo scenario accedendo al menu “Scenarios” in Setup.

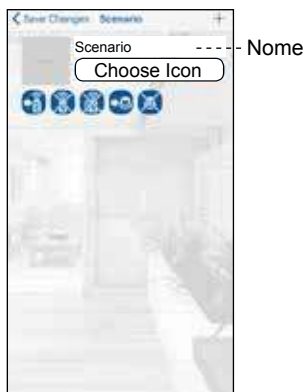

2. Premere “+” per aggiungere uno scenario. Scrivere un **Nome** e assegnare un'icona tra le 9 proposte.

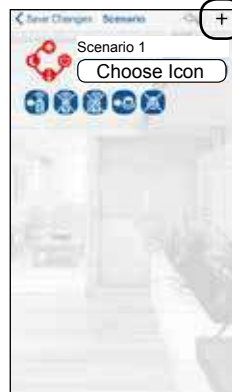

3. Premere “+” per aggiungere dei comandi remoti da qualsiasi stanza.

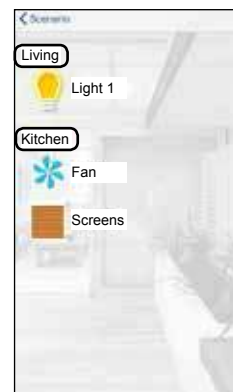

4. Selezionare il tipo di dispositivo dalla lista che appare.



5. Premere (Light 1) per aggiungere il primo comando.



6. Premere (ON) per scegliere il comando.



7. Il primo dispositivo configurato per lo scenario appare sullo schermo.



8. Ripetere i passi 3-4-5 per aggiungere gli altri dispositivi allo scenario.

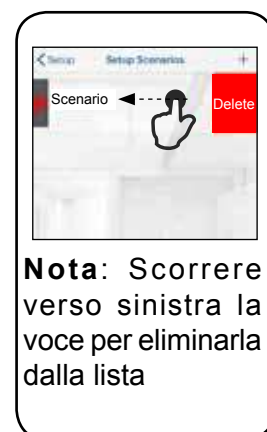

**Nota:** Scorrere verso sinistra la voce per eliminarla dalla lista



## 7.1 PROGRAMMAZIONE AVANZATA SCENARI

Una volta creato uno scenario è possibile assegnare la funzione di richiamo ad un tasto del telecomando oppure ad un pulsante (Normalmente aperto) collegato ai morsetti 4-5 della scheda.



Non utilizzato

-----Premere per cancellare tutti i pulsanti scenario associati ai pulsanti del telecomando.

----- Premere per cancellare il tasto del trasmettitore assegnato

----- Toccare l'icona e premere il pulsante del trasmettitore al quale si vuole assegnare lo scenario

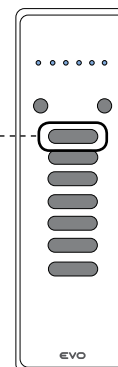

**Nota:** Scorrere verso sinistra la voce per eliminarla dalla lista.

## 8.0 TIMERS



1. Creare un nuovo timer accedendo al menu "Timers" in Setup.



2. Premere "+" per aggiungere un timer.



3. Premere "Light 1" per aggiungere un timer a questo trasmettitore.



4. Selezionare (ON) per scegliere il comando da inviare.



5. Abilitare i timers. Impostare l'ora per i timers.



6. Premere "Save Changes".



7. Ripetere i passi 2 e 3 per aggiungere dei timer agli altri dispositivi.



**Nota:** Scorrere verso sinistra la voce per eliminarla dalla lista.

**Nota:** Per funzionare i timers devono essere abilitati seguendo la seguente procedura:



1. Premere l'icona "rotella".

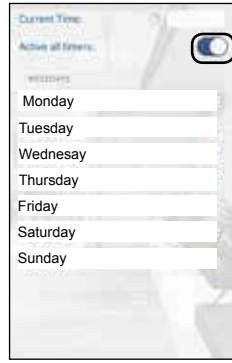

2. Selezionare (Active all timers) per abilitare i timers.

Abilita timers

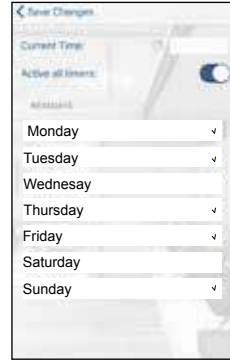

3. E' possibile impostare il gruppo weekdays-weekend. Selezionare il nome dei giorni per aggiungerli nel weekdays gruppo.

## 9.0 SCELTA DELLA SCHEDA

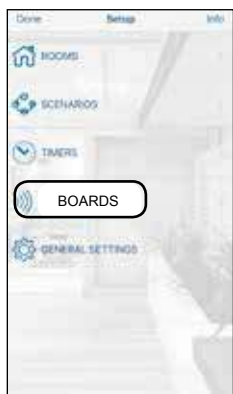

1. Premere (Boards) per accedere al menu successivo.



2. Selezionare la scheda desiderata. Per aggiungere una nuova scheda premere "+"



3. Per effettuare il collegamento premere (Select).

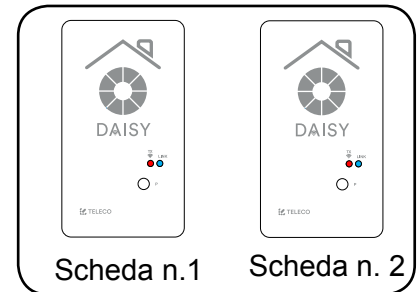

## 11.0 CONDIVIDERE L'INSTALLAZIONE (SEI ORE)

**Nota:** Prima di procedere è necessario eseguire una procedura di **Registrazione** sul nuovo Smartphone così come riportato al paragrafo 3.0

David.fogar@gmail.com  
 \*\*\*\*\*  
 Log In



Smartphone configurato

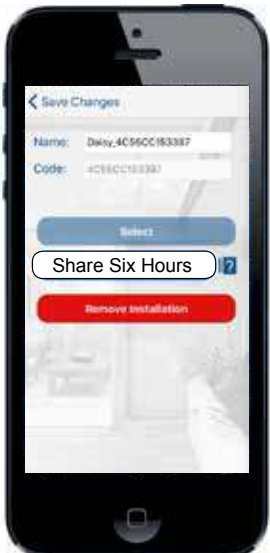

1. Premere (Share Six Hours).

Smartphone configurato

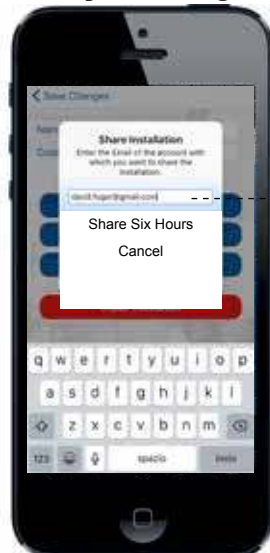

2. Inserire l'email della nuova registrazione eseguita sul nuovo Smartphone. Premere (Share Six Hours)

Nuovo smartphone



3. Accettare l'invito per condividere l'installazione.

## 12.0 IMPOSTAZIONI GENERALI

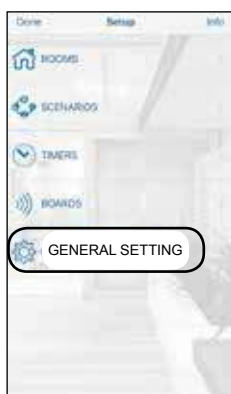

1. Premere (General Setting) per accedere al menu successivo

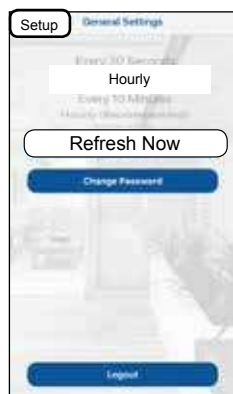

2. Selezionare Refresh time e premere (Setup). In alternativa premere (Refresh Now).

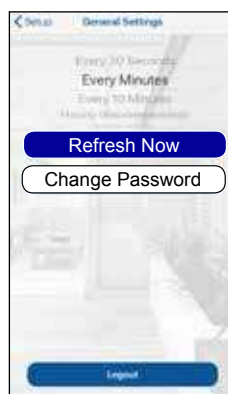

3. Per impostare una nuova password selezionare (Change Password).

### Suggerimento

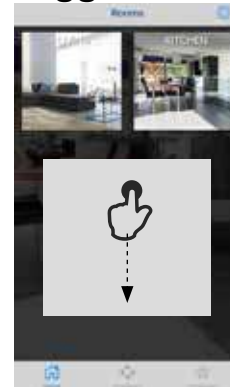

Scorrere verso il basso per aggiornare la configurazione.

## 13.0 PAGINA INFO



1. Premere (Info) per accedere al menu successivo.



----- Informazioni sulle configurazioni generali.

----- Informazioni sullo stato della scheda Daisy

----- Informazioni sul Software e Firmware installati

## 14.0 PAGINA PRINCIPALE

Una volta configurate le stanze con i trasmettitori premere “Done” per accedere alla pagina “Home” principale.



----- Setup Menu

----- Stanze create

----- Trasmettitori preferiti impostati

----- Scenari creati

## 14.1 TRASMETTITORI DAISY

**Nota:** Per funzionare i **trasmettitori Daisy** devono essere prima stati memorizzati nei ricevitori.  
Vedere procedure riportate ai par. 14.2 e par. 14.3

**1. Premere (Living o Kitchen room icon) per accedere al menu successivo.**

**2. Premere (Light icon) per accedere al menu successivo.**

**3. Premere (Fan o Screens icona) per accedere al menu successivo.**

**TRASMETTITORI DAISY**

Feedback (premere per richiesta)

Icona dinamica

ON comando      OFF comando

Premere per selezionare il successivo livello di preset

ON comando      OFF comando

Icona dinamica

OPEN comando      STOP comando      CLOSE comando

## 14.2 MEMORIZZAZIONE



Trasmettitore Daisy

Per il suo corretto funzionamento, il **trasmettitore Daisy** deve essere memorizzato nel ricevitore. Fare riferimento al manuale di istruzioni del ricevitore per la procedura di memorizzazione.

### 14.3 MEMORIZZAZIONE REMOTA DI ALTRI CODICI RADIO DA UN TRASMETTITORE STANDARD

**Nota:** Il tasto P3 si trova all'interno del trasmettitore. Il codice radio aggiunto avrà le stesse funzioni del codice usato per l'inserimento. La procedura è compatibile con qualsiasi tipo di trasmettitore.

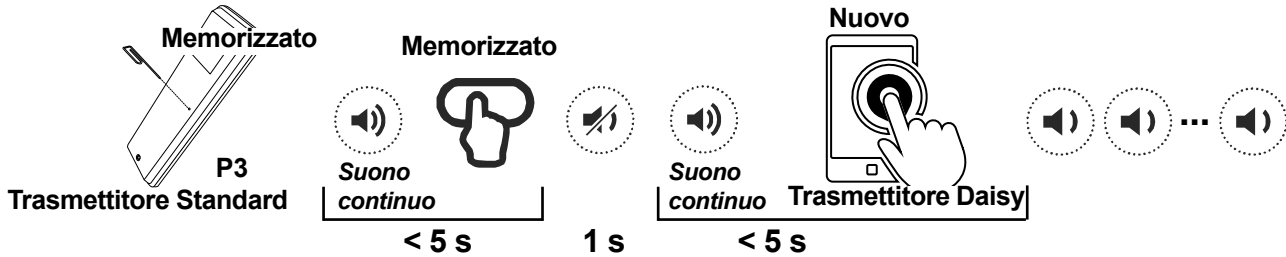

Premere il pulsante P3 del trasmettitore standard memorizzato e tenere premuto. Il buzzer emette un suono continuo. Premere un pulsante relativo a un codice già memorizzato. Il suono si interrompe per 1 secondo e quindi ritorna continuo. Premere un pulsante virtuale sul trasmettitore Daisy relativo al nuovo codice da memorizzare. La riuscita della memorizzazione è indicata dal suono intermittente del buzzer.

### 15.0 TRASMISSIONE SCENARI



1. Selezionare l'icona (Scenario) per accedere al menu successivo.



2. Selezionare l'icona (Scenario) per inviare lo scenario.



3. Premere (Yes) per inviare lo scenario.



**Nota:** Selezionare l'icona (i) per ottenere delle informazioni riguardo lo scenario impostato.

### 16.0 RESET DELLA CONFIGURAZIONE DELLA RETE WI-FI

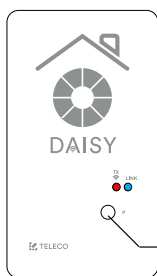

**Pulsante:** Reset della configurazione della rete Wi-Fi (\*)

\* I trasmettitori memorizzati non vengono cancellati.

Premere (P) una volta e tenere premuto per 5s:

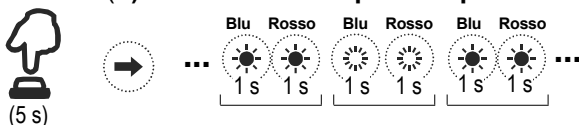

In alternativa premere e tenere premuto il pulsante (P) e allo stesso tempo alimentare la scheda Daisy:

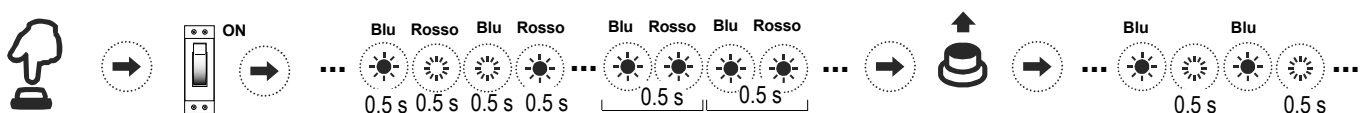

Problema	Soluzione
<p><i>Procedura - Prima configurazione:</i> I LED blu e rosso lampeggiano alternativamente per un lungo periodo</p>	<p>Attendere fino a quando i LED smettono di lampeggiare anche se appare il messaggio "Connessione tra scheda e telefono non riuscita". Se i LED continuano a lampeggiare, verificare che il router non abbia impostati dei filtri di blocco.</p>
<p><i>Procedura - Prima configurazione:</i> Il LED blu lampeggia lentamente - Connessione fallita</p>	<p>Verificare che i dati inseriti siano corretti e ripetere la procedura di prima configurazione.</p>
<p><i>Procedura - Prima configurazione</i> Problema di connessione segnale GPS</p>	<p>Verificare che la funzione GPS sia abilitata e impostata sulla modalità ad alta precisione</p>
<p><i>Modalità operativa normale:</i> Disconnessione dalla rete WiFi: i LED blu e rosso lampeggia alternativamente</p>	<p>Verificare che il router sia alimentato e connesso ad Internet.</p>
<p><i>Modalità operativa normale:</i> Nessuna connessione ad internet - LED Blu lampeggia ogni 0.3s</p>	<p>Controllare la connessione internet del router</p>
<p><i>Modalità operativa normale:</i> Modalità di emergenza - Il LED blu lampeggia ogni 0,1 s.</p>	<p>Disponibili solo comandi diretti. Controllare la connessione internet del router.</p>



**DAISY APP**

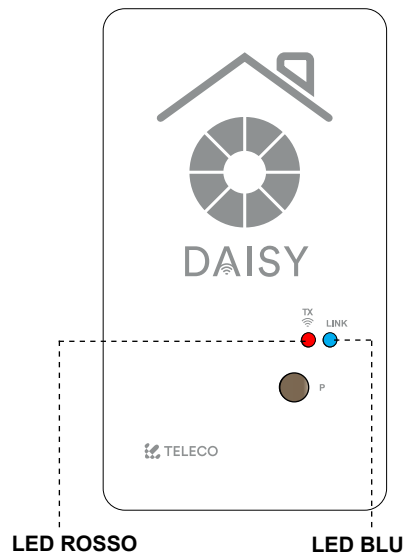



**IMPORTANTE! LEGGERE ATTENTAMENTE IL PRESENTE MANUALE PRIMA DI INSTALLARE O METTERE IN SERVIZIO IL PRODOTTO. CONSERVARE LE ISTRUZIONI PER FUTURA CONSULTAZIONE.**

**INSTALLAZIONE DEL PRODOTTO:** Il prodotto in oggetto deve essere installato, messo in servizio e controllato periodicamente solo da personale tecnico qualificato nel rispetto delle normative vigenti riguardanti le apparecchiature elettriche. Il produttore declina qualsiasi responsabilità in caso di danni derivanti da errata installazione o utilizzo non conforme del dispositivo

**INFORMAZIONI DI SICUREZZA:** La ricezione radio del dispositivo può essere disturbata se si hanno nell'ambiente emissioni elettromagnetiche provenienti da altre apparecchiature che trasmettono sulla stessa frequenza oppure se il dispositivo viene schermato da parti metalliche.

Il fabbricante, Teleco Automation s.r.l., dichiara che il tipo di Apparecchiatura radio è conforme alla direttiva 2014/53/UE. Il testo completo della dichiarazione di conformità UE è disponibile al seguente indirizzo Internet: [www.telecoautomation.com/ce](http://www.telecoautomation.com/ce).

**Nell'ottica di un continuo sviluppo dei propri prodotti, il produttore si riserva il diritto di apportare modifiche a dati tecnici e prestazioni senza preavviso.**

**INFORMAZIONE AGLI UTILIZZATORI:** Ai sensi dell'art. 26 del Decreto Legislativo 14 marzo 2014, n. 49 "Attuazione della Direttiva 2012/19/UE sui rifiuti di apparecchiature elettriche ed elettroniche". Il simbolo del cassonetto barrato riportato sull'apparecchiatura o sulla sua confezione indica che il prodotto alla fine della propria vita utile deve essere raccolto separatamente dagli altri rifiuti. L'utente dovrà, pertanto, conferire l'apparecchiatura giunta a fine vita agli idonei centri di raccolta differenziata dei rifiuti elettronici ed elettrotecnici, oppure riconsegnarla al rivenditore al momento dell'acquisto di una nuova apparecchiatura di tipo equivalente, in ragione di uno a uno. L'adeguata raccolta differenziata per l'avvio successivo dell'apparecchiatura dismessa al riciclaggio, al trattamento e allo smaltimento ambientalmente compatibile contribuisce ad evitare possibili effetti negativi sull'ambiente e sulla salute e favorisce il reimpiego e/o riciclo dei materiali di cui è composta l'apparecchiatura. Lo smaltimento abusivo del prodotto da parte dell'utente comporta l'applicazione delle sanzioni di cui al D.Lgs. 152/2006

**TELECO AUTOMATION S.R.L.**

**ITALY**  
Tel. +39.0438.388511  
info@telecoautomation.com

**TELECO AUTOMATION FRANCE**

**FRANCE**  
Tel. +33.(0)472.145080  
info@telecofrance.com

**TELECO AUTOMATION GMBH**

**GERMANY**  
Tel. +49.(0)8122.9563024  
info.de@telecoautomation.com

**TELECO AUTOMATION OCEANIA PTY LTD**

**AUSTRALIA**  
Tel. +61.(07)5502.7801  
info@telecoautomation.com.au



**DAISY WI-FI : INTERFACE WI-FI, GÉRÉE DEPUIS UNE APPLICATION, POUR PILOTER À DISTANCE TOUS LES APPAREILS TELECO DEPUIS UN SMARTPHONE.**

Code Produit:

# TVDAYxxxA01

## Caractéristiques

- Disponible à la fois en 868.3MHz et 916MHz.
- Accès simple via Wi-Fi ou réseau mobile depuis n'importe quel appareil compatible.
- Jusqu'à 50 points de commande
- Possibilité de créer des scénarios.
- Horloge hebdomadaire pour l'envoi d'ordres planifiés.



APP DAISY

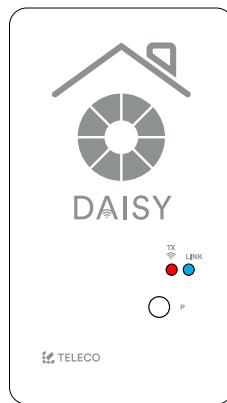

868.3MHz  
916MHz



868.3MHz  
916MHz \*

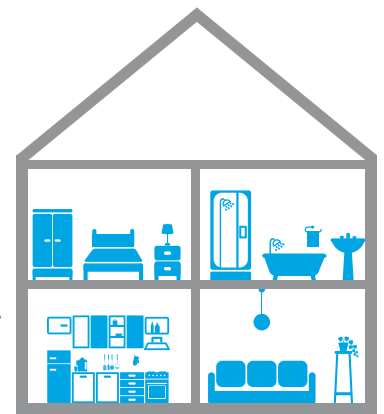

\* Les récepteurs "Blue Series" sont bi-directionnels. Ils peuvent exécuter des ordres et renvoyer un rapport d'état au DAISY

## 1.0 CARACTÉRISTIQUES

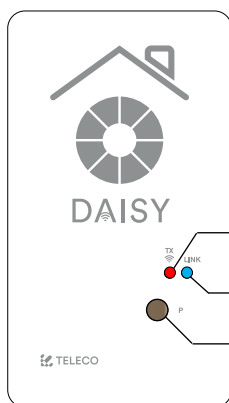

- LED:** Émission d'ordres radio
- LED:** Réseau Wi-Fi
- Bouton:** Réinitialisation de la configuration Wi-Fi (\*)

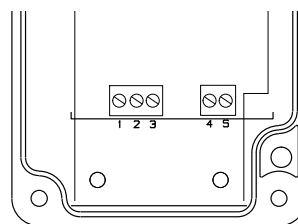

1. +12 ÷ 24Vcc
2. GND (-)
3. +5Vcc
4. COMMUN
5. ENTRÉE CONTACT N.O.

### Thermoplastic ABS

Ne doit pas être exposé directement aux UV.

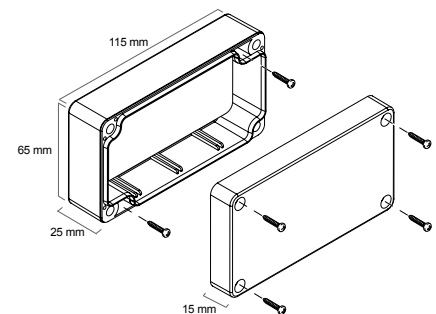

Le produit correctement assemblé est certifié IP54.

\* Les émetteurs mémorisés ne sont pas supprimés.

## 1.1 SPÉCIFICATIONS TECHNIQUES

- Fréquence d'émission	868.3 MHz (TVDAY868A01) 916MHz (TVDAY916A01)	- Émetteurs virtuels max.	50
- Alimentation	5 / 12 ÷ 24Vdc	- Protection	IP54
- Plage de températures	-20° ÷ +50°C	- Matière du boîtier et du couvercle	Thermoplastic ABS
		- Compatibilité normes Wi-Fi	802.11 b/g/n
		- Bande de fréquence	2.4GHz

TVDAYXXXA01

DOC.: T799.01\_FR

DATE: 08/03/19

## 2.0 INSTALLATION

INSTALLATION Téléchargez l'application DAISY depuis l'App Store ou Google Play. Vérifiez au préalable la compatibilité avec votre appareil. Une fois téléchargé, il est possible de l'utiliser en mode DEMO, même sans appareil DAISY.



⚠ Pour connecter le dispositif Daisy au réseau Wifi, le router ne doit pas avoir de filtres de blocage pré-réglés. En cas de problèmes de connexion, contactez l'administrateur du système.

## 3.0 ENREGISTREMENT

Le smartphone doit être connecté à Internet. Suivez la procédure décrite ci-dessous :



1. Cliquez sur **Create new account**.



2. Remplissez les différents champs.



3. Une fois remplis, cliquez sur **Sign In**

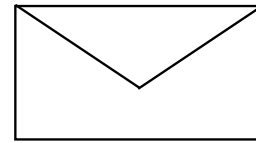

4. Attendez la réception de l'email de confirmation.



5. Entrez vos identifiants et mot de passe puis cliquez sur **Log In**

## 4.0 PREMIÈRE CONFIGURATION AVEC UN APPAREIL ANDROID

**Version require:** Version Android 4.4 KitKat ou suivantes.



1. Lancez l'application DaisyCode



2. Remplissez le champ avec le code indiqué sur l'étiquette.

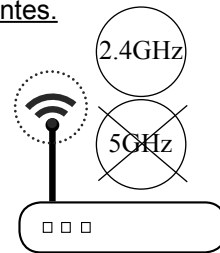

**Name:** Orange\_WiFi\_Network  
**Password:** 12345678

3. Notez le **Nom** et le **Mot de passe** du réseau WiFi.



4. Sélectionnez votre réseau Wifi.



5. Entrez le **mot de passe** du réseau et appuyez sur **Continue**

**Attention:** vérifiez que dans votre Smartphone l'option de connexion aux réseaux Wifi sans accès à Internet soit activée.

## 4.1 PREMIÈRE CONFIGURATION AVEC UN APPAREIL IOS

**Version require :** Version IOS 12.0 ou suivantes



1. Sur votre téléphone, connectez-vous au réseau WiFi "Daisy\_4C55..." et lancez l'application Daisy.



2. Notez le Code inscrit au dos de l'appareil.

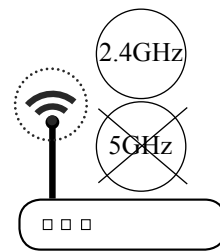

**Name:** Orange\_WiFi\_Network  
**Password:** 12345678

3. Notez le **Nom** et le **Mot de passe** du réseau WiFi



4. Sélectionnez votre réseau Wifi.

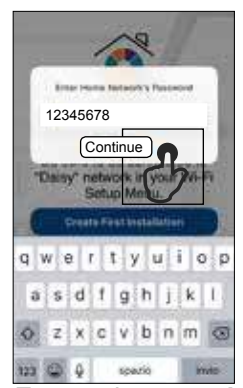

5. Entrez le **mot de passe** du réseau et appuyez sur **Continue**

## 5.0 FONCTIONS DES LEDS

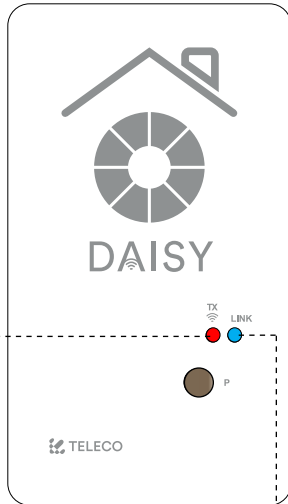

**LED ROUGE:** Émission d'ordre radio

**LED BLEUE:** Réseau Wi-Fi

Émission	<b>TX (LED ROUGE): Ordres radio</b>
<b>Active</b>	<b>ON</b>
<b>Non Active</b>	<b>OFF</b>
État connexion Wi-Fi	<b>LINK (LED BLEUE): Réseau Wi-Fi</b>
<b>En attente de connexion</b>	<p><b>Blu</b>      <b>Blu</b>      <b>Blu</b></p> <p>...  1 s  1 s  ...</p>
<b>Connexion</b>	<p><b>Blu Rosso Blu Rosso Blu Rosso</b></p> <p>...  0.5 s  0.5 s  0.5 s ...</p>
<b>Connexion</b>	<p><b>Blu</b>      <b>Blu</b>      <b>Blu</b></p> <p>...  0.5 s  0.5 s  ...</p>
<b>Connecté</b>	<p><b>Blu</b></p> <p> <b>ON</b></p>

## 6.0 MENU PRINCIPAL

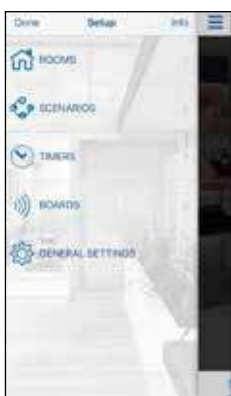

- Connexion directe à travers le router WiFi
- Connexion via Cloud
- Pas de connexion (carte non accessible)

Tabbar : Home - Scenarios - Favoris

## 6.1 PARAMÉTRAGE DES PIÈCES.

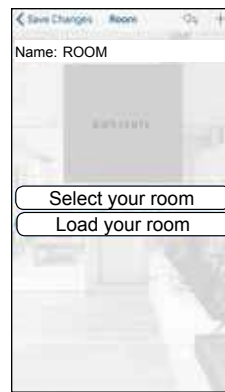

1. Créez de nouvelles pièces via le menu "Rooms" dans "Setup".

2. Cliquez sur (+) pour ajouter une pièce

3. Cliquez sur (Room) pour entrer dans le menu suivant

4. Entrez le nom et choisissez une image parmi les 6 fournies ("Select your room") ou choisissez en une dans la galerie de votre appareil.

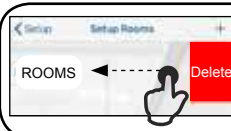

**Note:** glissez vers la gauche pour supprimer une pièce.

## 6.2 AJOUTER UN POINT DE COMMANDE À UNE PIÈCE

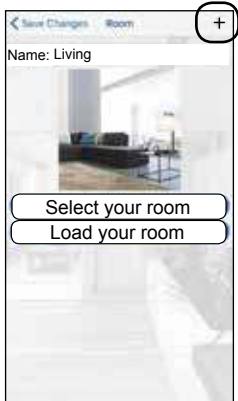

1. Cliquez sur "+" pour ajouter des émetteurs. Sélectionnez le type d'appareil piloté depuis la liste.



2. Cliquez sur l'émetteur à ajouter.

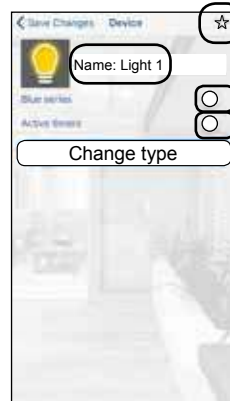

3. Attribuer un Nom.

----- Ajouter aux Favoris

----- Valider si le récepteur un "Blue Series"  
----- Valider pour activer les ordres planifiés.



**Note:** glissez vers la gauche pour supprimer un émetteur

## 7.0 SCENARIOS



1. Créez de nouveaux scénarios via le menu "Scenarios" dans "Setup".



2. Cliquez sur "+" pour ajouter un scénario. Saisissez le nom et attribuez une icône parmi les 9 fournies.



3. Cliquez sur "+" pour ajouter des émetteurs depuis n'importe quelle pièce.

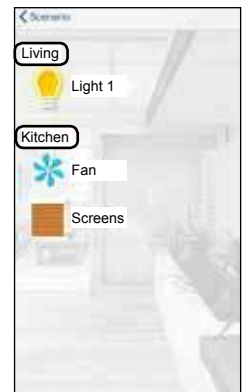

4. Sélectionnez le type d'appareil piloté depuis la liste.



5. Cliquez sur (Lum.1) pour ajouter le premier ordre.



6. Cliquez sur (ON) pour choisir l'ordre.



7. Le 1er appareil configuré pour le scénario s'affiche



8. Répéter les étapes 3-4-5 pour ajouter d'autres appareils au scénario

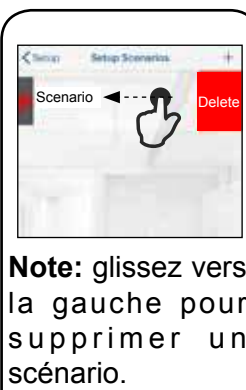

**Note:** glissez vers la gauche pour supprimer un scénario.

## 7.1 PROGRAMMATION SCÉNARIO AVANCÉE

Une fois le scénario finalisé, il est possible de l'attribuer à un émetteur ou à un bouton filaire N.O poussoir connecté sur l'entrée 4-5.



Non utilisé

----- Cliquez pour supprimer tous les émetteurs associés

----- Cliquez et appuyez sur le bouton de l'émetteur à supprimer

----- Cliquez et appuyez sur le bouton de l'émetteur à attribuer

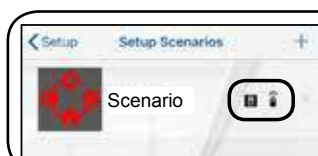
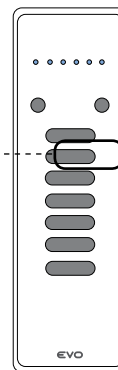

**Nota:** Scorrere verso sinistra la voce per eliminarla dalla lista.

## 8.0 HORLOGE



1. Créez une nouvelle horloge via le menu "Timers" dans "Setup."



2. Cliquez sur "+" pour ajouter une horloge.



3. Cliquez sur "Lum. 1" pour ajouter une horloge.



4. Cliquez sur (ON) pour choisir l'ordre.



5. Cliquez sur (ON) pour choisir l'ordre.



6. Cliquez sur "Save Changes".



7. Répétez les étapes 2 et 3 pour ajouter des horloges aux autres appareils.



**Note:** glissez une horloge sur la gauche pour la supprimer.

**Note:** pour fonctionner, les temporisateurs doivent être activés selon la procédure suivante :



1. Appuyez sur l'icône "roue".

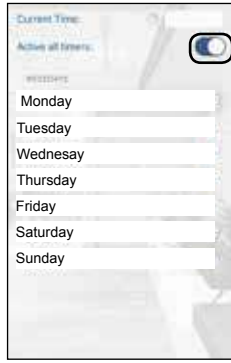

2. Cliquez sur (Active all timers) pour activer les horloges.

Abilita timers

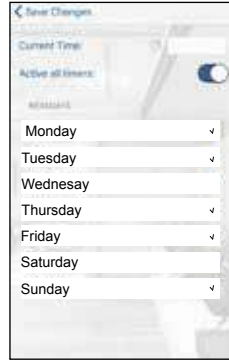

3. Il est possible de paramétrer des groupes semaine/week-end. Cliquez sur le nom des jours à ajouter dans les groupes.

## 9.0 SÉLECTION DU DAISY À PILOTER

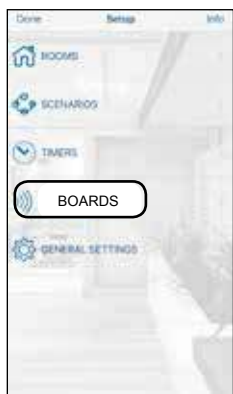

1. Cliquez sur (Boards).



2. Cliquez sur le Daisy voulu. Pour ajouter un nouveau Daisy, cliquez sur (+).

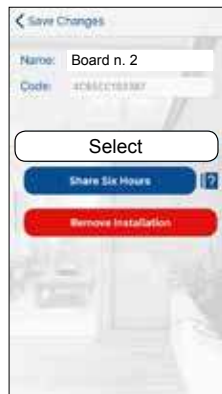

3. Pour appairer le Daisy cliquez sur (Select).

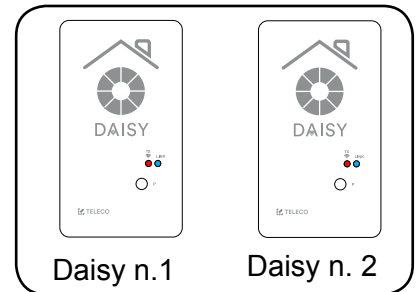

## 11.0 PARTAGE D'INSTALLATION (SIX HEURES)

**Note:** Avant de commencer, il est nécessaire de procéder à la procédure d'**Enregistrement** sur le nouveau smartphone décrite au paragraphe 3.0.

David.fogar@gmail.com  
 \*\*\*\*\*  
 Log In

Ancien smartphone

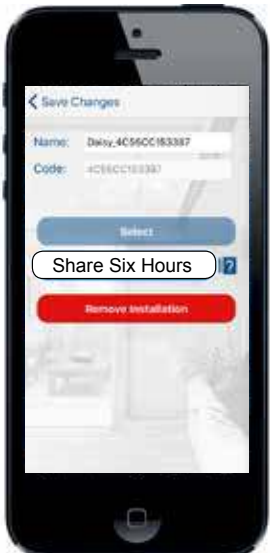

1. Cliquez sur (Share Six Hours).

Ancien smartphone

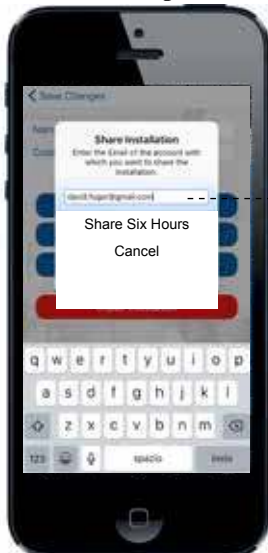

2. Renseignez les champs avec l'email du nouveau téléphone. Cliquez sur (Share ...) installation.

Nouveau smartphone



3. Acceptez l'invitation à partager l'installation.

## 12.0 PARAMÈTRES GÉNÉRAUX



1. Cliquez sur (General Setting).

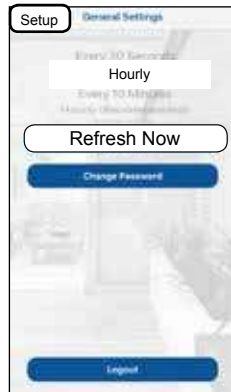

2. Choisissez la fréquence de mise à jour et cliquez sur (Setup). Sinon cliquez sur (Update Now).

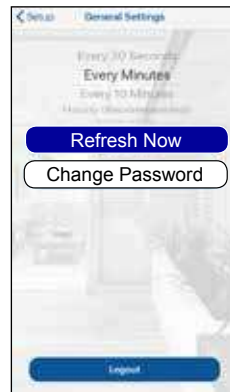

3. Pour changer le mot de passe, cliquez sur (Change Password)



## 13.0 PAGE D'ACCUEIL



1. Cliquez sur (Info)



Informations concernant les configurations générales

Informations concernant l'état de la carte Daisy

Informations concernant le Software et le Firmware installés.

## 14.0 PAGE D'ACCUEIL

Une fois les pièces configurées, cliquez sur (done) pour arriver sur la page d'accueil (Home).



Menu configuration

Paramétrage des pièces

Paramétrage des émetteurs favoris

Paramétrage des scénarios

## 14.1 ÉMETTEURS DAISY

**Note:** Les émetteurs virtuels Daisy doivent être mémorisés dans les récepteurs. Voir §14.2 et §14.3.

**1.** Cliquez sur l'icône (Salon ou Cuisine).

**2.** Cliquez sur l'icône (Lum. 1).

**3.** Cliquez sur l'icône (Ventilation ou Volets).

**ÉMETTEURS DAISY**

Retour d'info. (cliquez pour interroger)

Icône dynamique

ON OFF

Cliquez pour activer le niveau suivant

ON OFF

Icône dynamique

OUVERTURE STOP FERMETURE

## 14.2 MÉMORISATION



Émetteur Daisy

Pour un fonctionnement correct, il est nécessaire de mémoriser l'émetteur virtuel Daisy dans le récepteur à piloter. Référez-vous au manuel du récepteur concerné pour la procédure de mémorisation.



### 14.3 MÉMORISATION À DISTANCE D'UN ÉMETTEUR VIRTUEL DEPUIS UN ÉMETTEUR STANDARD

**Note:** Le bouton P3 est situé à l'intérieur de l'émetteur standard. Le nouvel émetteur virtuel aura les mêmes fonctions que l'émetteur utilisé pour la copie. Cette procédure est compatible avec n'importe quel émetteur standard.

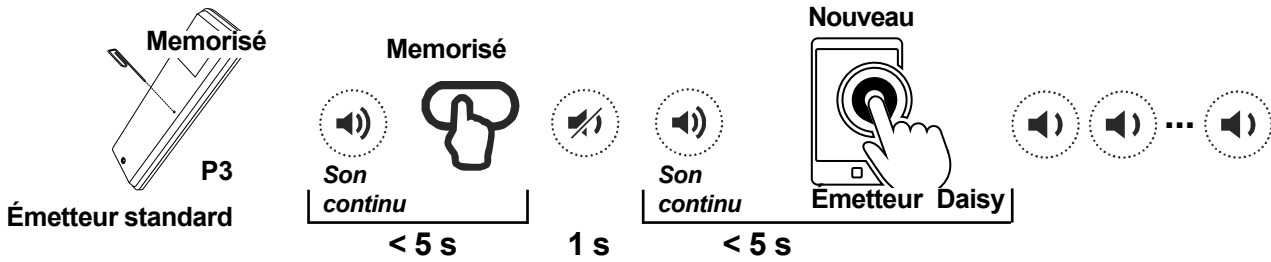

Appuyez et maintenez le bouton P3 de l'émetteur standard mémorisé. Le buzzer émet un bip continu. Appuyez sur une touche de l'émetteur déjà mémorisé. Le buzzer arrête de biper pendant 1s puis bipe continu de nouveau. Appuyez sur le bouton du nouvel émetteur Daisy. Le succès de la mémorisation est signalé par un bip rapide.

### 15.0 LANCEMENT DE SCÉNARIO



1. Cliquez sur l'icône (Scénario)



2. Cliquez sur le scénario à lancer.



3. Cliquez sur (Yes) pour le lancer

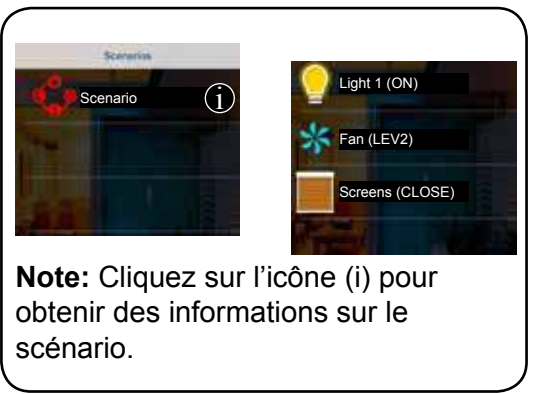

**Note:** Cliquez sur l'icône (i) pour obtenir des informations sur le scénario.

### 16.0 RÉINITIALISATION DE LA CONFIGURATION WI-FI

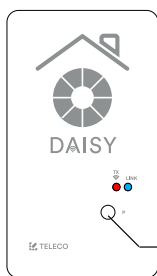

**Bouton:**  
Réinitialisation de la configuration Wi-Fi (\*)

\* Les émetteurs mémorisés ne sont pas supprimés.

Appuyez sur le bouton (P) 1 fois et maintenez pendant 5s.:

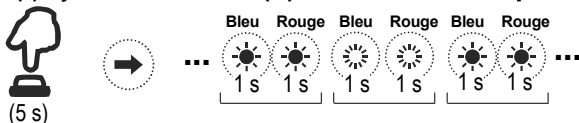

En alternative, appuyez et gardez appuyé le bouton (P) et au même temps donnez alimentation à la carte Daisy :

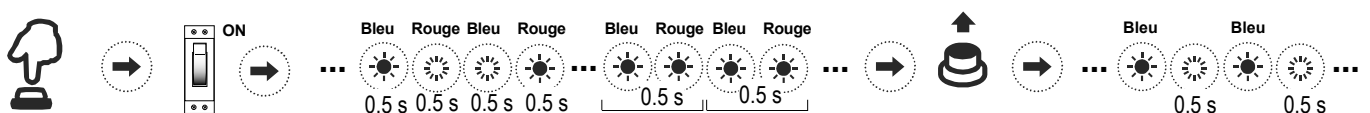

Problème	Solution
<p><i>Procédure – Première configuration :</i> Les LEDs bleus et rouges clignotent alternativement pendant une longue période.</p>	<p>Attendez jusqu'à quand les LEDs s'arrêtent de clignoter même si le message "Connexion entre carte et téléphone échouée" apparaît. Si les LEDs continuent à clignoter, vérifiez que le router n'ait pas de filtres de blocage pré-réglés.</p>
<p><i>Procédure – Première configuration :</i> La LED bleu clignote lentement – Connexion échouée</p>	<p>Vérifiez que les données saisies soient correctes et répétez la procédure de la première configuration.</p>
<p><i>Procédure – Première configuration :</i> Problème de connexion au signal GPS</p>	<p>Vérifiez que la fonction GPS soit activée et réglée sur la modalité à haute précision</p>
<p><i>Modalité de fonctionnement normal :</i> Coupure au réseau WiFi : les LEDs blues et rouges clignotent alternativement</p>	<p>Vérifiez que le router soit alimenté et connecté à Internet.</p>
<p><i>Modalité de fonctionnement normal :</i> Pas de connexion à internet – la LED bleue clignote tous les 0.3 secondes</p>	<p>Vérifiez la connexion internet du router.</p>
<p><i>Modalité de fonctionnement normal:</i> Mode d'urgence – La LED bleue clignote tous les 0.1 secondes</p>	<p>Seulement commandes directes disponibles. Vérifiez la connexion internet du router.</p>



**DAISY APP**

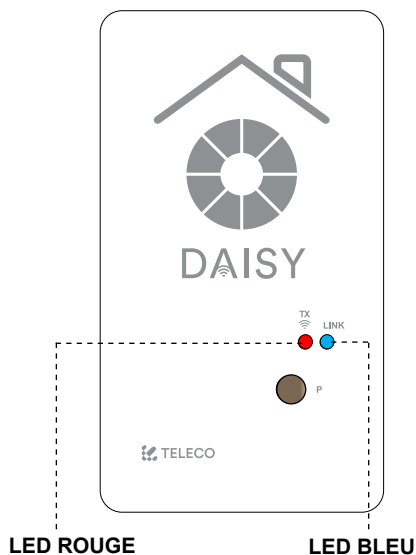



**IMPORTANT ! LISEZ ATTENTIVEMENT CE MANUEL AVANT D'INSTALLER OU DE METTRE EN FONCTION L'APPAREIL. CONSERVEZ LES NOTICES POUR TOUTE CONSULTATION FUTURE.**

## **INSTALLATION DU PRODUIT**

Le produit en objet doit être installé, mis en service et vérifié périodiquement seulement par des techniciens qualifiés, conformément aux normes en vigueur pour les appareillages électriques.

## **AVERTISSEMENTS DE SÉCURITÉ**

La réception radio du dispositif peut être affectée si dans l'environnement il y a des perturbations radioélectriques créées par d'autres appareils émettant sur la même bande de fréquence ou si l'appareil se trouve dans un boîtier avec parties métalliques. N'utilisez pas l'appareil dans des endroits ou dans des systèmes sensibles aux émissions radio (aéroports, hôpitaux, etc.). L'opérateur n'est en aucun cas protégé contre les brouillages causés par d'autres équipements ou systèmes de télécommunication (par exemple, des systèmes radioélectriques autorisés fonctionnant sur la même gamme de fréquences). Si vous rencontrez des problèmes avec son rayon d'action, fixez le périphérique très haut.

## **ÉLIMINATION DU PRODUIT**

Le fabricant, Teleco Automation s.r.l, déclare que le type d'équipement radio est conforme avec la directive 2014/53/EU. Le texte intégral de la déclaration de conformité EU est disponible à l'adresse internet suivante: [www.telecoautomation.com/ce](http://www.telecoautomation.com/ce).

INFORMATIONS UTILISATEURS en application de l'art. 14 de la DIRECTIVE 2012/19/UE DU PARLEMENT EUROPÉEN ET DU CONSEIL du 4 juillet 2012 relative aux déchets d'équipements électriques et électroniques (DEEE). Le symbole de la poubelle barrée appliqué sur l'équipement ou sur son emballage indique qu'en fin de vie, le produit doit être collecté et traité séparément des autres déchets urbains en mélange. Prière de contacter sa mairie, ou une autorité locale, pour obtenir des informations sur les systèmes de collecte séparée disponibles sur le territoire. Le revendeur est tenu de reprendre gratuitement l'équipement usagé lors de l'achat d'un équipement neuf équivalent, pour l'acheminer vers une filière de recyclage ou d'élimination agréée. La collecte séparée de l'équipement hors d'usage en vue de son recyclage, de son traitement et de son élimination compatible avec l'environnement contribue à prévenir les effets indésirables sur l'environnement et la santé et favorise le réemploi et le recyclage des matériaux qui le constituent.

**Dans l'optique d'un développement continu de ses produits, le constructeur se réserve le droit d'apporter sans préavis des modifications aux données techniques et aux prestations.**