

Mini-Dynaflex® II

For Serial No. 6B1660 and Higher

Air Tool Manual – Safety, Operation and Maintenance

SAVE THIS DOCUMENT, EDUCATE ALL PERSONNEL

Models:

15003 – Basic Tool

15006 – Versatility Kit



⚠ WARNING

Read and understand this tool manual before operating your air tool. Follow all safety rules for the protection of operating personnel as well as adjacent areas. Always operate, inspect and maintain this tool in accordance with the American National Safety Institute (ANSI) Safety Code for Portable Air Tools – B186.1. For additional safety information, refer to Safety Requirements for the Use, Care and Protection of Abrasive Wheels – ANSI B7.1, Code of Federal Regulation – CFR 29 Part 1910, European Committee for Standards (EN) Hand Held Non-Electric Power Tools – Safety Requirements and applicable State and Local Regulations.

SAFETY LEGEND

	⚠ WARNING Read and understand tool manual before work starts to reduce risk of injury to operator, visitors, and tool.	⚠ WARNING Practice safety requirements. Work alert, have proper attire, and do not operate tools under the influence of alcohol or drugs.	
	⚠ WARNING Eye protection must be worn at all times, eye protection to conform to ANSI Z87.1.	⚠ WARNING Ear protection to be worn when exposure to sound, exceeds the limits of applicable Federal, State or local statutes, ordinances and/or regulations.	
	⚠ WARNING Respiratory protection to be used when exposed to contaminants that exceed the applicable threshold limit values required by law.	⚠ WARNING Air line hazard, pressurized supply lines and flexible hoses can cause serious injury. Do not use damaged, frayed or deteriorated air hoses and fittings.	

⚠ WARNING

Some dust created by sanding, grinding, drilling, and other construction activities contain chemicals known to cause cancer, birth defects or other reproductive harm. Some examples of these chemicals are:

- Lead from lead-based paints
- Crystalline silica from bricks and cement and other masonry products
- Arsenic and chromium from chemically treated lumber

Your risk from these exposures varies, depending on how often you do this type of work. To reduce your exposure to these chemicals: work in a well ventilated area, and work with approved safety equipment, such as those dust masks that are specially designed to filter out microscopic particles.

SAFETY INSTRUCTIONS

Carefully Read all instructions before operating or servicing any Dynabrade® Abrasive Power Tool.

Products offered by Dynabrade are not to be modified, converted or otherwise altered from the original design without expressed written consent from Dynabrade, Inc.

Tool Intent: Dynaflex® abrasive belt machine replaces tedious hand filing and sanding and can be used for grinding, deburring, blending and polishing. Tool can be used on most materials including metal, plastic, fiberglass, composites, rubber, glass and stone.

Do not use tool for anything other than its intended applications.

This power tool is not intended for use in potentially explosive atmospheres and is not insulated against contact with electrical power.

Training: Proper care, maintenance, and storage of your tool will maximize its performance.

- Employer's Responsibility – Provide Dynaflex® operators with safety instructions and training for safe use of tools and accessories.

Accessory Selection:

- Abrasive/accessory RPM (speed) rating MUST be approved for AT LEAST the tool RPM rating.
- Before mounting an accessory, visually inspect for defects. Do not use defective accessories.
- Mount only recommended accessories. See manual and Dynabrade catalog.
- Follow tool specifications before choosing size and type of accessory.
- Only use recommended fittings and air line sizes. (See tool Machine Specifications table.)

(continued on next page)

OPERATING INSTRUCTIONS

Warning: Always wear eye protection. Operator of tool is responsible for following: accepted eye, face, respiratory, hearing and body protection.

Caution: Hand, wrist and arm injury may result from repetitive work, motion and overexposure to vibration.

- Only use recommended fittings and air line sizes. Air supply hoses and air hose assemblies must have a minimum working pressure rating of 150 PSIG (10 Bars, g) or 150 percent of the maximum pressure produced in the system, whichever is higher. (See tool Machine Specifications table.)
- Keep hand and clothing away from working end of the air tool.
- Be sure that any loose clothing, hair and all jewelry is properly restrained.
- Secure inlet bushing on air tool with a wrench before attempting to install the air fitting to avoid damaging housing assembly.
- Check tool RPM (speed) with tachometer with air pressure set at 90 PSIG while the tool is running. If tool is operating at a higher speed than the RPM marked on the tool housing, or operating improperly, the tool must be serviced and corrected before use.

Caution: Tool RPM must never exceed abrasive/accessory RPM rating. Check accessory manufacturer for details on maximum operating speed or special mounting instructions.

- Disconnect air hose from tool when changing belts and contact arms.
- Connect air tool to power source. Be careful NOT to depress throttle lever in the process. **Do not expose air tool to inlet pressure above 90 PSIG or (6.2 Bars).**

Caution: After installing the accessory, before testing or use and/or after assembling tool, the Dynaflex® must be started at a reduced speed to check for good balance. Gradually increase tool speed. DO NOT USE if tool vibration is excessive. Correct cause, and retest to insure safe operation.

- Make sure that work area is uncluttered, and visitors are at a safe range from the tools and debris.
- Use a vise or clamping device to hold work piece firmly in place.
- Do not apply excessive force on tool or apply "rough" treatment to it.
- Always work with a firm footing, good posture and proper lighting.
- Make sure that work area is uncluttered, and visitors are at a safe range from the tools and debris. Potentially explosive atmospheres can be caused by dust and fumes resulting from sanding or grinding. Always use dust extraction or suppression systems which are suitable for the material being processed.

Report to your supervisor any condition of the tool, accessories, or operation you consider unsafe.

Air System

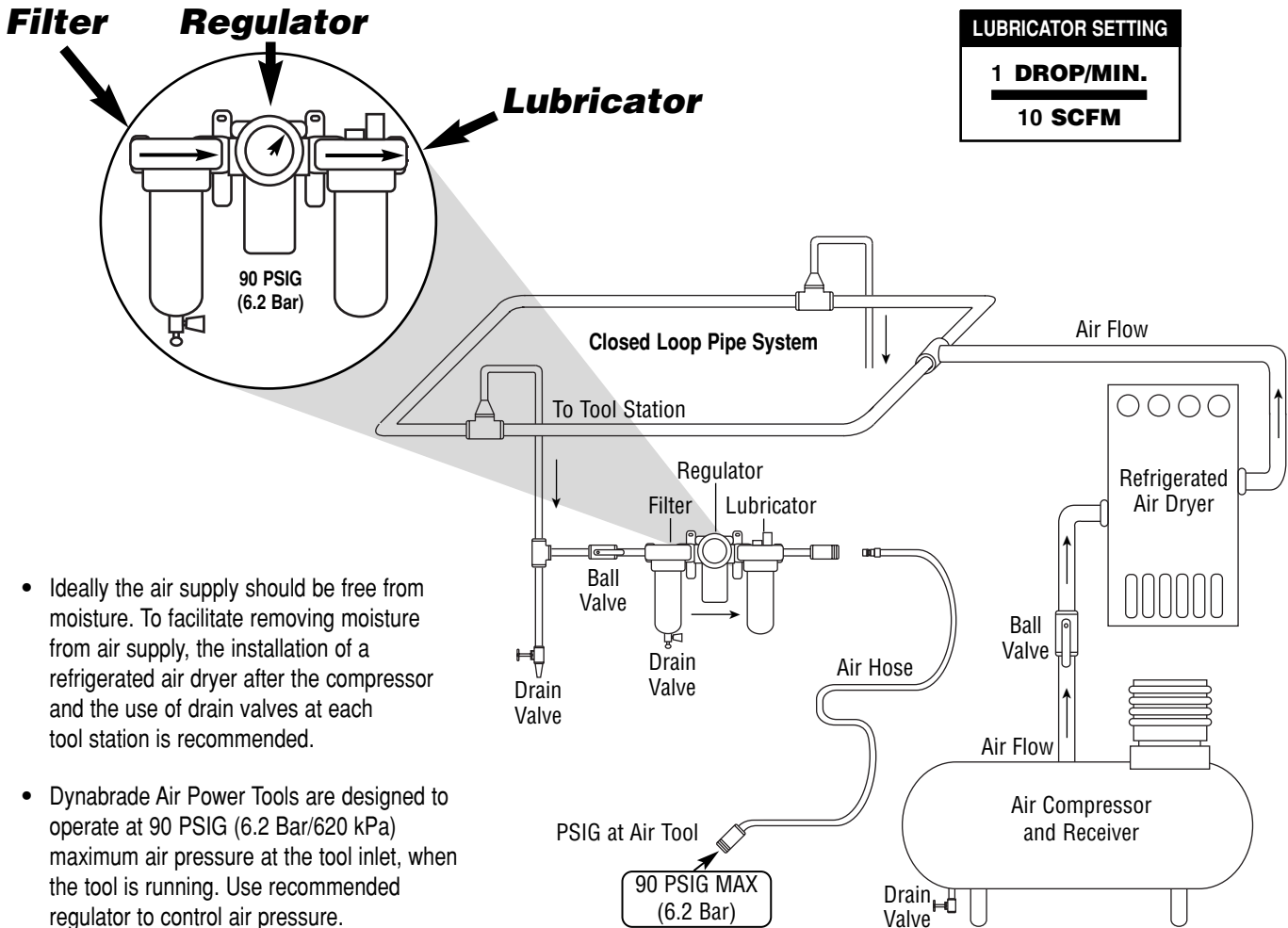

- Ideally the air supply should be free from moisture. To facilitate removing moisture from air supply, the installation of a refrigerated air dryer after the compressor and the use of drain valves at each tool station is recommended.
- Dynabrade Air Power Tools are designed to operate at 90 PSIG (6.2 Bar/620 kPa) maximum air pressure at the tool inlet, when the tool is running. Use recommended regulator to control air pressure.

Machine Specifications

Model Number	Motor HP (W)	Motor RPM	Max. SFPM (SMPM)	Sound Level	Air Flow Rate CFM/SCFM (LPM)	Abrasive Belt Size Inch (mm)	Weight Pound (kg)	Length Inch (mm)	Height Inch (mm)
All Models	.4 (298)	25,000	4,890 (1,486)	78 dB(A)	3/20 (566)	1/8"-1/2" (3-13)W x 12" (305)L	1.8 (.82)	10-3/4 (275)	3-1/2 (89)

Additional Specifications: Air Inlet Thread 1/4" NPT • Hose I.D. Size 1/4" or 8mm • 90 PSIG (6.2 Bars)

Maintenance Instructions

Important: A Preventative Maintenance Program is recommended whenever portable power tools are used.

- Use only genuine Dynabrade replacement parts to insure quality. To order replacement parts, specify **Model #**, **Serial #** and **RPM** of your air tool.
- It is strongly recommended that all Dynabrade rotary vane air tools be used with a Filter-Regulator-Lubricator to minimize the possibility of misuse due to unclean air, wet air or insufficient lubrication. Dynabrade recommends the following: **11405** Air Filter-Regulator-Lubricator (FRL) – Provides for air pressure regulation, two stage filtration of water and contaminants. Operates 40 SCFM/1,133 LPM @ 100 PSIG with 3/8" NPT female ports.
- Dynabrade recommends one drop of air lube per minute for every 10 SCFM (example: if the tool specification states 40 SCFM, set the drip rate on the filter-lubricator to 4 drops per minute). Dynabrade Air Lube (P/N **95842**: 1 pt 473 ml) is recommended.

Routine Preventative Maintenance: Check free speed of Dynafite® using a tachometer.

- Mineral spirits are recommended when cleaning the tool and parts. Do not clean tool or parts with any solvents or oils containing acids, esters, ketones, chlorinated hydrocarbons or nitro carbons.
- **DO NOT** clean or maintain tools with chemicals that have a low flash point (example: WD-40®).
- A Motor Tune-Up Kit (P/N **96074**) is available which includes high wear and medium wear motor parts.
- Air tool labels must be kept legible at all times, if not, reorder label(s) and replace. User is responsible for maintaining specification information i.e.: Model #, S/N, and RPM. (See Assembly Breakdown)
- Blow air supply hose out prior to initial use.
- Visually inspect air hoses and fittings for frays, visible damage and signs of deterioration. Replace damaged or worn components.
- Refer to Dynabrade's Warning/Safety Operating Instructions Tag (Reorder No. **95903**) for safety information.

After maintenance is performed on tool, add a few drops of Dynabrade Air Lube (P/N **95842**) to the air line and start the tool a few times to lubricate air motor. Check for excessive tool vibration.

Handling and Storage:

- Use of tool rests, hangers and/or balancers is recommended.
- Protect tool inlet from debris (see Notice below).
- **DO NOT** carry tool by air hose.
- Protect abrasive accessories from exposure to water, solvents, high humidity, freezing temperature and extreme temperature changes.
- Store accessories in protective racks or compartments to prevent damage.

Notice

All Dynabrade motors use the highest quality parts and metals available and are machined to exacting tolerances. The failure of quality pneumatic motors can most often be traced to an unclean air supply or the lack of lubrication. Air pressure easily forces dirt or water contained in the air supply into motor bearings causing early failure. It often scores the cylinder walls and the rotor blades resulting in limited efficiency and power. Our warranty obligation is contingent upon proper use of our tools and cannot apply to equipment which has been subjected to misuse such as unclean air, wet air or a lack of lubrication during the use of this tool.

One Year Warranty

Following the reasonable assumption that any inherent defect which might prevail in a product will become apparent to the user within one year from the date of purchase, all equipment of our manufacture is warranted against defects in workmanship and materials under normal use and service. We shall repair or replace at our factory, any equipment or part thereof which shall, within one year after delivery to the original purchaser, indicate upon our examination to have been defective. Our obligation is contingent upon proper use of Dynabrade tools in accordance with factory recommendations, instructions and safety practices. It shall not apply to equipment which has been subject to misuse, negligence, accident or tampering in any way so as to affect its normal performance. Normally wearable parts such as bearings, contact wheels, rotor blades, etc., are not covered under this warranty.

Abrasive Belt and Contact Arm Assembly Change / Housing Angle Adjustment

To Change Abrasive Belts:

1. Disconnect the tool from the power source.
2. Loosen the **15119** Captive Screw and remove the **15103** Guard Assembly.
3. Pull back the **15101** Tension Arm and remove the abrasive belt.
4. Install a new abrasive belt, and the **15103** Guard Assembly.
5. Connect the tool to the power source and adjust the belt tracking by turning the **15108** Knob.

To Change Contact Arm Assemblies:

1. Disconnect the tool from the power source.
2. Loosen the **15119** Captive Screw and remove the **15103** Guard Assembly.
3. Pull back the **15101** Tension Arm and remove the abrasive belt.
4. Loosen the **15108** Knob to remove the contact arm assembly.
5. Install the desired contact arm assembly so that the tab on the end of the arm faces toward the **15101** Tension Arm.
6. Fasten the contact arm assembly in place with the **15108** Knob.
7. Install a new abrasive belt, and the **15103** Guard Assembly.
8. Connect the tool to the power source and adjust the belt tracking by turning the **15108** Knob.

Housing Angle Adjustment:

1. To pivot the **15115** Housing Assembly, use a 3mm hex key to loosen the **01788** Motor Lock Screw.
2. Pivot the housing assembly and fasten it to the desired position.

Index Key

No. Part # Description

1	15119	Captive Screw
2	15103	Guard Assembly
3	15102	Gasket
4	15100	Housing
5	01788	Motor Lock Screw
6	40029	Motor Lock
7	04115	Air Motor
8	96086	Roll Pin (3)
9	15112	Retainer Clip (2)
10	15110	Wiper (2)
11	15108	Knob
12	15101	Tension Arm
13	11040	Spring
14	96085	Spring (2)
15	15105	Support Shaft (2)
16	15105	Contact Arm Assy. (Refer to page 6)
17	15118	Drive Wheel
18	15106	Exhaust Cover
19	15111	Silencer
20	01580	Silencer
21	02649	Bearing
22	54529	Shim Pack (3/Pkg)
23	01478	Front Bearing Plate
24	50767	Pin (2)
25	01479	Spacer
26	01475	Rotor
27	01480	Blades (4)
28	01476	Cylinder
29	02673	Rear Bearing Plate
30	02696	Bearing
31	02679	Shield
32	01546	Housing
33	01548	Gasket
34	01461	Lock Nut
35	01558	Collar
36	95523	O-Ring
37	01470	Insert
38	01448	Throttle Lever
39	01462	Safety Lock Lever
40	12132	Pin
41	95558	Retaining Ring
42	02117	Housing
43	01449	Valve Stem
44	95730	O-Ring
45	01024	O-Ring
46	01469	Speed Regulator Assembly (Includes O-Rings)
47	01464	Seal
48	01472	Tip Valve
49	01468	Spring
50	01683	Air Control Ring
51	01564	Spacer
52	95711	Retaining Ring
53	01486	Felt Silencer (4)
54	96065	O-Ring
55	01446	Air Deflector
56	95620	Retaining Ring
57	01578	Inlet Adapter
58	94535	Muffler Assembly

Mini-Dynafile® II

Complete Assembly Breakdown

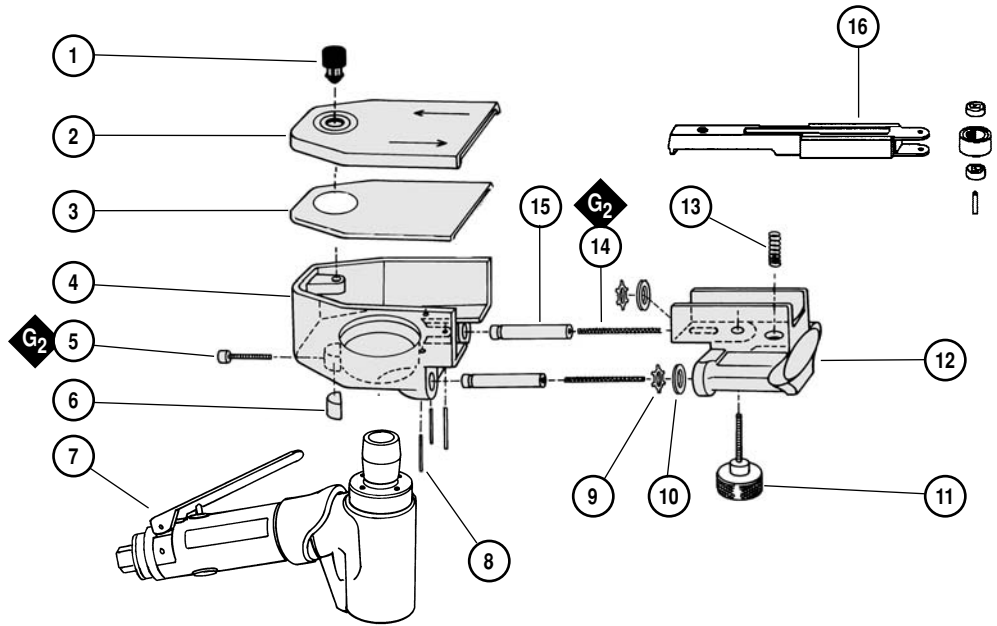

Note: Shaded parts represent 15115 Housing Assembly.

04115 Air Motor

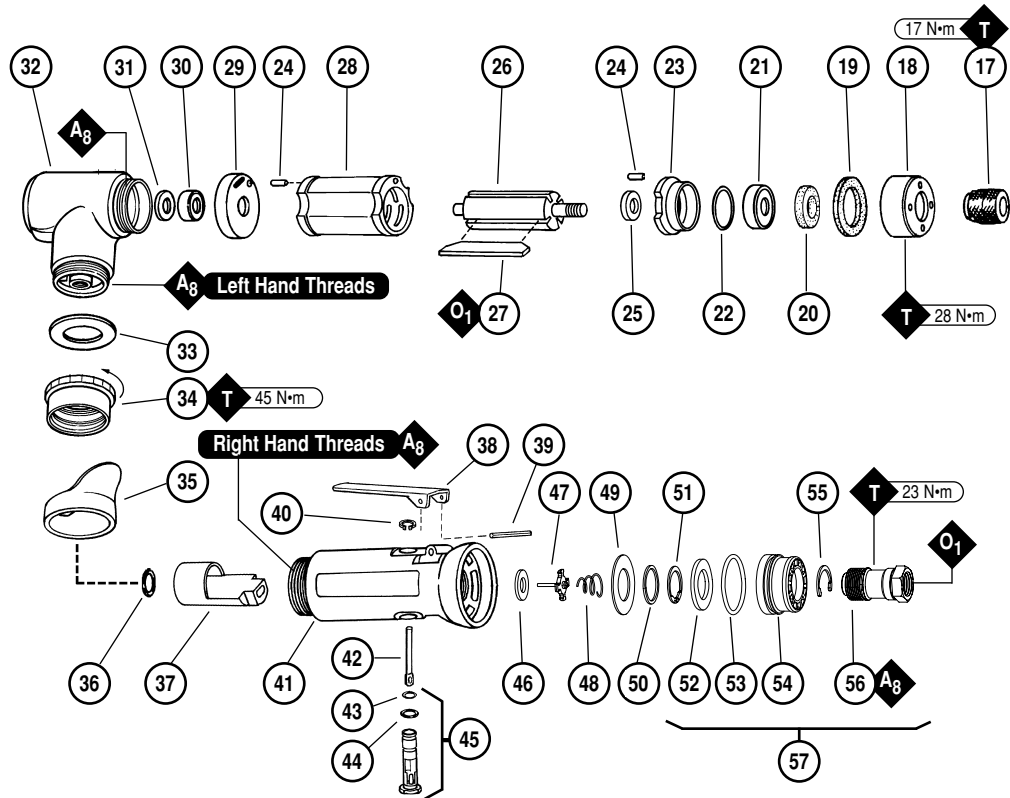

KEY	
O	Oil: O₁ = Air Lube
A	Adhesive: A₃ = Loctite #242 A₈ = Loctite #567 A₉ = Loctite #587
T	Torque: N·m x 8.85 = In. - lbs.
G	Grease: G₂ = Loctite #771

Disassembly/Assembly Instructions - Mini-Dynafite® II

Important: The Manufacturing Warranty is void if the tool is disassembled before the warranty expires, by anyone other than a Dynabrade® Approved Repair Technician.

Notice: A 96074 Motor Tune-Up Kit is available. Also, the special repair tooling referred to in these instructions can be ordered through your Dynabrade® Distributor. Please refer to this tool manual for correct part number identification.

Important: Always follow these steps before servicing any part of this air tool.

1. Shut off the air supply, and depress throttle lever to dissipate the remaining air. Carefully disconnect the tool from the air supply hose.
Note: Use a wrench to hold the air tool inlet adapter stationary when removing the air supply connection.
2. Remove the 15103 Guard, abrasive belt and contact arm assembly. Use a 3mm hex key to loosen the 01788 Motor Lock Screw and remove the 15115 Housing Assembly from the air motor.

Motor Disassembly:

1. Place the 52296 Repair Collar around the 01546 Housing and fasten in a vise so that the 15118 Drive Wheel is pointing up.
2. Use the 50971 Lock Ring Tool or an adjustable 3mm pin spanner wrench to remove the 15106 Exhaust Cover by turning it counterclockwise. Remove the felt silencers.
3. Carefully pull the air motor out of the 01546 Housing. Remove the 02679 Shield.
4. Fasten the 96346 2" Bearing Separator around the portion of the 01476 Cylinder that is closest to the 02673 Rear Bearing Plate. Place the bearing separator on the table of the 96232 #2 Arbor Press so that the drive wheel is pointing down. Use a 3/16" or 5mm diameter flat end drive punch as a press tool and push the rotor out of the 02696 Rear Bearing. Use the 96210 Bearing Removal Tool and the arbor press to remove the 02696 Bearing from the rear bearing plate.
5. Fasten the vane slot portion of the rotor in a vise with aluminum or bronze jaws so that the drive wheel is pointing up.
6. Use the 95262 14mm Wrench to remove the 15118 Drive Wheel by turning it counterclockwise.
7. Remove the front bearing/plate, shims and 01479 Spacer.

Motor Disassembly Complete.

Valve Disassembly:

1. Position the 52296 Repair Collar around the 02117 Housing and fasten the tool in a vise so that the 01578 Inlet Adapter is pointing up.
2. Remove the 01578 Inlet Adapter by turning it counterclockwise.
3. Use needle nose pliers to remove the 01468 Spring and the 01472 Tip Valve. Use a small screwdriver to remove the 01464 Seal.
4. Position the 02117 Housing so that the 12132 Pin, throttle lever, and 01449 Valve Stem can be removed.
5. Use retaining ring pliers to remove the 95558 Retaining Ring and then push the 01469 Speed Regulator Assembly out of the valve housing.

Valve Disassembly Complete.

Important: Clean and inspect all parts for wear before assembling. Note: Follow all lubrication, adhesive, and torque specifications.

Valve Assembly:

1. Install the 01469 Speed Regulator Assembly (with o-rings) into the valve housing and hold it in place with the 95558 Retaining Ring.
2. Position the 52296 Repair Collar around the 02117 Housing and fasten the tool in a vise so that the 12132 Pin, throttle lever, and 01449 Valve Stem can be installed.
3. Position the 52296 Repair Collar around the 02117 Housing and fasten the tool in a vise so that the air inlet opening is pointing up.
4. Install the 01464 Seal into the 02117 Housing so that it is laying flat.
5. Use needle nose pliers to install the 01472 Tip Valve so that the metal pin passes through the hole in the 01449 Valve Stem.
6. Install the 01468 Spring so that the smaller end of the spring fits against the back of the tip valve.
7. Refer to the exploded view of the muffler assembly for the correct order of assembly.
8. Apply a small amount of the Loctite® #567 (or equivalent) to the external threads of the 01578 Inlet Adapter and install the 94535 Muffler Assembly onto the 02117 Housing. (Torque to 23N·m/200 in. lbs.)
9. Hold the tool air inlet adapter stationary with a wrench when attaching or installing the air supply connection.

Valve Assembly Complete.

Motor Assembly:

1. Install the 01479 Spacer onto the rotor.
2. Select .003" (.08mm) thickness shims from the 54529 Shim Pack and install these into the 01478 Front Bearing Plate.
3. Install the 02649 Bearing into the front bearing plate.
4. Position the rotor in a vise with aluminum or bronze jaws so that the rotor spindle is pointing up. Install the front bearing/plate onto the rotor.
5. Install the 01580 Silencer around the rotor spindle. Install the 15111 Silencer into the 15106 Exhaust Cover and place these onto the rotor. Install the 15118 Drive Wheel. (Torque to 17N·m/150 in. lbs.) Remove the assembly from the vise.
6. Use a .001" (0.3mm) thick feeler gauge to check the clearance between the front bearing plate and the face of the rotor.
7. The clearance should be .001"-.0015" (0.3-0.4mm). **Note:** If the clearance needs adjustment repeat steps 2-6 adding or removing shims as required.
8. Lubricate the 01480 Blades (4) with the 95842 Dynabrade Air Lube 10W/NR (or equivalent) and install these into the rotor.
9. Install the 01476 Cylinder over the rotor so that the air inlet opening of the cylinder will line up with the air inlet opening in the 02673 Rear Bearing Plate.
10. Use the raised outer diameter of the 96216 Bearing Press Tool and the 94232 #2 Arbor Press to install the 02696 Bearing into the 02673 Rear Bearing Plate.
11. Use the raised inner diameter of the 96216 Bearing Press Tool and the arbor press to install the rear bearing/plate onto the rotor. **Note:** Carefully press the bearing/plate down until it just touches the cylinder. This will establish a snug fit between the bearing plates and the cylinder.
12. Apply a small amount of petroleum lubricant onto the seal of the 02696 Bearing and install the 02679 Shield so that it will stick against seal of the bearing.
13. Carefully slide the motor assembly into the 02117 Housing.
14. Use the 50971 Lock Ring Tool or a adjustable 3mm pin spanner wrench to fasten the 15106 Exhaust Cover onto the 02117 Housing. (Torque to 28N·m/250 in. lbs.)

Motor Assembly Complete.

Throttle Positioning Procedure:

Important: Carefully perform this procedure so as not to entirely separate the 01546 Housing from the 02117 Housing. Loosen the 01461 Lock Nut only enough to make the desired throttle lever adjustment.

1. Place the 52296 Repair Collar around the 02117 Housing and fasten it in a vise so that the 01546 Housing is pointing up.
2. Slip the 01558 Collar down onto the 02117 Housing to expose the 01461 Lock Nut.
3. With a firm hold on the 01546 Housing use a 34mm or an adjustable wrench to turn the lock nut clockwise to loosen the 01546 Housing from the 02117 Housing.
4. Orient the throttle lever to the operators desired grip and positioning. **Note:** Allow for additional rotation of the 01546 Housing as the 01461 Lock Nut is tightened.
5. Grasp the 01546 Housing firmly to reduce its rotation. Use a 34mm or an adjustable wrench to tighten the 01461 Lock Nut. (Torque to 45 N·m/400 in. lbs.)

(continued on next page)

6. Slip the **01558** Collar back over the **01461** Lock Nut.

Note: The factory preset positioning for the throttle lever is the 11:00 position. This is in relation to the drive wheel positioning at 12:00.

Throttle Positioning Procedure Complete.

Final Assembly:

1. Install the **15115** Housing Assembly onto the air motor and use a 3mm hex key to tighten the motor lock screw. Install the contact arm assembly, abrasive belt and **15103** Guard.
2. With the air supply shut off, carefully connect the tool to the air supply hose. **Note:** Use a wrench to hold the air tool inlet adapter stationary when install the air supply connection.

Final Assembly Complete. Tool Assembly Complete.

Please allow 30 minutes for the adhesives to cure before operating tool. Important: The motor should be tested for proper operation.

Apply 3 Drops of the **95482** Dynabrade Air Lube 10W/NR (or equivalent) into the air inlet adapter with the throttle lever depressed. Carefully connect the tool to an air supply. The tool should operate within 10% of the maximum rated RPM. The tool RPM should not exceed the maximum rated RPM with an operating air supply pressure of 90 PSIG (6.2 bar g).

Preventative Maintenance Schedule

For All Mini-Dynaflex® II Models

This service chart is published as a guide to expectant life of component parts. The replacement levels are based on average tool usage over one year. Dynabrade Inc. considers one year usage to be 1,000 hours.

LEGEND	
T	Included in Tune-Up Kit
X	Type of wear, no other comments apply.
L	Easily lost. Care during assembly/disassembly.
D	Easily damaged during assembly/disassembly.
R	Replace each time tool is disassembled.



96074 – Motor Tune-Up Kit

Index #	Part Number	Description	Number Required	High Wear 100%	Medium Wear 70%	Low Wear 30%	Non-Wear 10%
1	15119	Captive Screw	1			D	
2	15103	Guard Assembly	1				L
3	15102	Gasket	1	X			
4	15100	Housing	1			X	
5	01788	Motor Lock Screw	1			X	
6	40029	Motor Lock	1				L
7	04115	Air Motor	1	N/A	N/A	N/A	N/A
8	96086	Roll Pin	3			X	
9	15112	Retainer Clip	2			X	
10	15110	Wiper	2			X	
11	15108	Knob	1				X
12	15101	Tension Arm	1				X
13	11040	Spring	1			X	
14	96085	Spring	2			X	
15	15105	Support Shaft	2			X	
16	See Note	Contact Arm Assy.	1	N/A	N/A	N/A	N/A
17	15118	Drive Wheel	1				X
18	15106	Exhaust Cover	1				X
19	15111	Silencer	1	T			
20	01580	Silencer	1	T			
21	02649	Bearing	1		T		
22	54529	Shim Pack (3/Pkg)	1		T		
23	01478	Front Bearing Plate	1			X	
24	50767	Pin	2				X
25	01479	Spacer	1				X
26	01475	Rotor	1	T			
27	01480	Blades (4/Pkg)	1			X	
28	01476	Cylinder	1				X
29	02673	Rear Bearing Plate	1		T		
30	02696	Bearing	1		T		
31	02679	Shield	1				X
32	01546	Housing	1		T		
33	01548	Gasket	1				X
34	01461	Lock Nut	1			X	
35	01558	Collar	1			T	
36	95523	O-Ring	1			D	
37	01470	Insert	1			X	
38	See Note	Throttle Lever	1			X	
39	12132	Pin	1		T		
40	95558	Retaining Ring	1			T	
41	02117	Housing	1			X	
42	01449	Valve Stem	1			T	
43	95730	O-Ring	1			X	
44	01024	O-Ring	1			X	
45	01469	Speed Regulator Assembly	1			T	
46	01464	Seal	1			T	
47	01472	Tip Valve	1			T	
48	01468	Spring	1			T	
49	01683	Air Control Ring	1				L
50	01564	Spacer	1			X	
51	95711	Retaining Ring	1			T	
52	01486	Felt Silencer	4	T			
53	96065	O-Ring	1			T	
54	01446	Air Deflector	1				X
55	95620	Retaining Ring	1			T	
56	01578	Inlet Adapter	1			X	

Note: Please refer to pages 4 of tool manual for specific part number.

Mini-Dynaflex® II Contact Arm Assemblies

Contact Wheel Assembly Includes wheel, bearing and shaft.

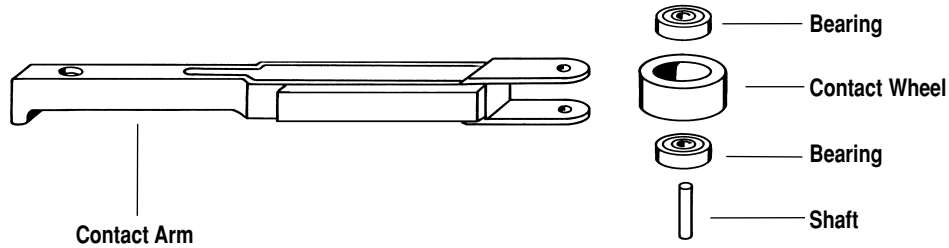

Mini-Dynaflex® II Standard Contact Arms

Part Number	Abrasive Belt Size	Contact Wheel Description	Contact Wheel Assembly	Contact Wheel Only	Bearing (2) Req.	Shaft
15026	1/2" x 12"	5/8" D x 3/8" W, Rubber	11078	11077	11052	11054
15028	1/4" or 1/2" x 12"	1" D x 3/8" W, Rubber	11080	11079	11052	11054
15029	1/8" x 12"	1" D x 3/8" W Urethane, Tapered	11086	11085	11052	11054
15030	1/2" x 12"	5/16" D x 3/8" W, Steel	11068	11067	11051	11054
15031	1/2" x 13"	7/16" D x 3/8" W, Rubber	11070	11069	11051	11054

Mini-Dynaflex® II Standard Contact Arms

Contact arms allow for 3" workable reach.
Contact Wheels noted include bearing and shaft.

15026 (Standard on all models).
Grind over contact wheel or platen.

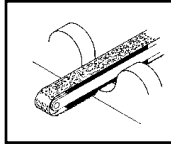

Belt Size: 1/2" wide x 12" long.

11078 Contact Wheel: 5/8" diameter x 3/8" wide, rubber.

11026 Platen: 1/2" wide.

15029

Grind corners, enter grooves, strap polish.



V-Tapered

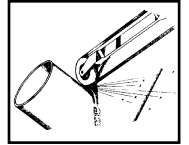

Belt Size: 1/8" wide x 12" long.

11086 Contact Wheel: 1" diameter x 3/8" wide, urethane.

No Platen

15028

Grind corners, enter grooves, strap polish.

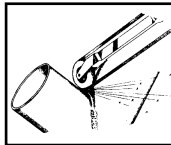

Belt Size: 1/4" or 1/2" wide x 12" long.

11080 Contact Wheel: 1" diameter x 3/8" wide, rubber.

No Platen

15030

Enter channels as narrow as 7/16".

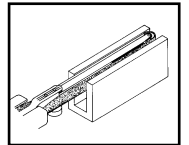

Belt Size: 1/2" wide x 12" long.

11068 Contact Wheel: 5/16" diameter x 3/8" wide, steel.

11027 Platen: 1/2" wide.

15031

For 13" long belts

Runs at 45 PSIG max.

Work on contact wheel or Dynapad.

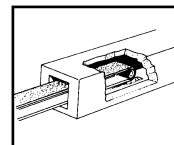

Belt Size: 1/2" wide x 13" long.

11070 Contact Wheel: 7/16" diameter x 3/8" wide, rubber.

11027 Platen: 1/2" wide.

Optional Accessories

FIND THE MOST CURRENT OFFERING OF SUPPORT DOCUMENTS AND ACCESSORIES @ WWW.DYNABRADE.COM



Composite Dynaswivel®

Swivels 360° at two locations which allows an air hose to drop straight to the floor, no matter how the tool is held.

- **94300:** 1/4" NPT.



96074 Motor Tune-Up Kit:

- Includes assorted parts to help maintain and repair motor.



50971 Lock Ring Tool

- Lock Ring Tool has a 3/8 in. square socket for use with 3/8 in. drive; breaker bar, ratchet head, or torque wrenches.



Dynabrade Air Lube

- Formulated for pneumatic equipment.
- Absorbs up to 10% of its weight in water.
- Prevents rust and formation of sludge.
- Keeps pneumatic tools operating longer with greater power and less down time.

95842: 1 pt. (473 ml)

95843: 1 gal. (3.8 L)



Threaded Collet Inserts

These uniquely designed inserts thread directly into the drive wheel.

01644 – 1/4" insert

01646 – 6mm insert

01647 – 1/8" insert

01648 – 3mm insert

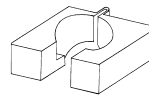

52296 Repair Collar

- Specially designed collar for use in vise to prevent damage to valve body of tool during disassembly/assembly.



96216 Bearing Press Tool

- This tool is designed to safely press a bearing into a bearing plate and onto a shaft.



96210 Bearing Removal Tool

- This tool is designed to pass through the I.D. of the bearing plate and push against the I.D. of the bearing.



11288 Dynaflex Contact Arm and Idler Wheel Repair Kit

- Contains special tools to assist in the replacement of contact wheels and bearings.

Abrasives

12" Long Abrasive Belts

Aluminum Oxide

Belt Width	Grit						
	40	60	80	120	180	220	320
1/8"	—	—	92206	92207	92208	92209	92210
1/4"	92105	92106	92107	92108	92118	92119	92120
1/2"	92110	92111	92112	92113	92114	92115	92116

Abrasive Impregnated Non-Woven Nylon

Belt Width	Super Fine Grey	Very Fine Blue	Medium Maroon	Coarse Brown
	1/2"	90311	90312	90313

Reference Contact Information

1. American National Safety Institute – ANSI
 25 West 43rd Street
 Fourth Floor
 New York, NY 10036
 Tel: 1 (212) 642-4900
 Fax: 1 (212) 398-0023

2. Government Printing Office – GPO
 Superintendent of Documents
 Attn. New Orders
 P.O. Box 371954
 Pittsburgh, PA 15250-7954
 Tel: 1 (202) 512-1803

3. European Committee for Standardization
 Rue de Stassart 36
 B - 1050 Brussels, Belgium

