

Measuring Light Screen Receiver BMRL632A

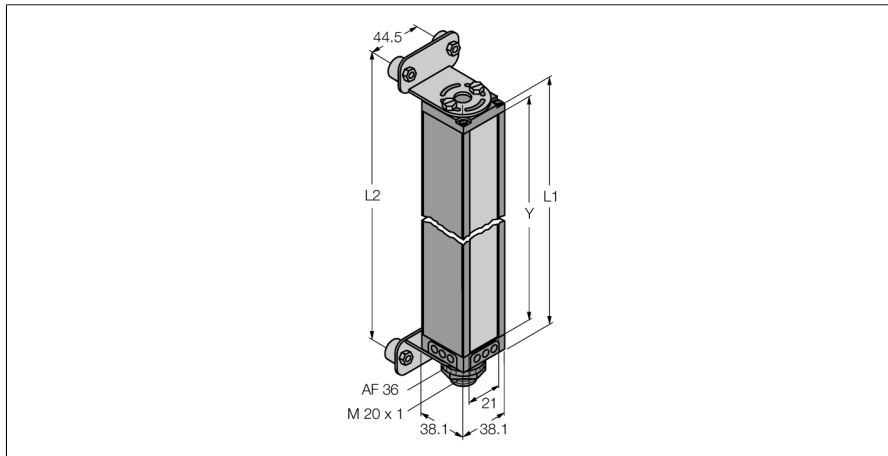

- Minimum target size 9.7 mm
- Scan field 133 mm
- Max. sensing range 6.1 m
- Operating voltage 11.8...12.2 VDC (from controller)
- Protection class IP65
- Adjustment via software

Functional principle

Measuring light screens are ideally suited for precise detection and inspection tasks such as product profiling, sizing, edge and centre guiding, hole and parts detection and the like. Each system consists of an emitter, receiver and a controller module, which is equipped with several switching and analogue outputs, depending on the specific version. The device also enables data transmission via RS232 or R485, either in a binary or ASCII code format. The scan times depend on the height of the measuring array and the adjusted scan mode. Detailed information can be taken from the instruction manual.

Type designation	BMRL632A
Ident no.	3039922
Function	Opposed mode sensor (receiver)
Optical resolution	9.7 mm
Scan field	133 mm
Number of beams	16
Ambient temperature	-20...+70 °C
Operating voltage	11.4...14 VDC
Approvals	CE
Approvals	cULus recognized
Design	Rectangular, Mini Array
Dimensions	38.1 x 38.1 x 201 mm
Housing material	Metal, AL
Lens	plastic, Acrylic
Electrical connection	Connector, 7/8"
Protection class	IP65