

Post Office Box 97
 Benton Harbor, Michigan
 Ph: 269/926-6171
 Fax: 269/925-8288

PART NUMBER: STD105
 REVISION: G

Product Specifications

Model Number	MAX. PRESS.		MAX. SPEED	HP	kW	Net Wt.	
	bar.	PSI				lbs.	kg
1UP-NRV-4-GR11	5.6	80	400 RPM	.31	0.23	3.1	1.41
* 1UP-NRV-4A-GR11	5.6	80	400 RPM	.31	0.23	3.1	1.41
1UP-NRV-11-GR11	5.6	80	400 RPM	.31	0.23	3.1	1.41

SOUND LEVEL 78 dba MAX.
 NORMAL AMBIENT +1°C. - 120°C.
 RELATIVE HUMIDITY 0% - 100%
 ENVIRONMENT HAZARDOUS AMBIENT COMBUSTIBLE
GAS AND DUST +1°C TO +40°C

CONFORMS TO EUROPEAN STANDARD EN13463-1
 NON-ELECTRICAL EQUIPMENT FOR EXPLOSIVE
 ATMOSPHERES GROUP II, CAT 2 (GAS AND DUST)
 PROTECTED BY CONSTRUCTION
 (SURFACE TEMP. RATED 135°C).

* DENOTES INACTIVE

* TECHNICAL DATA SUBJECT TO CHANGE
 WITHOUT NOTICE.

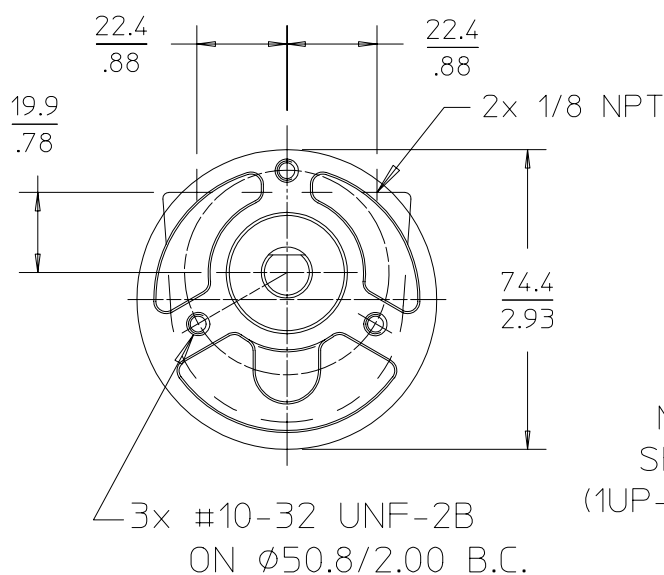
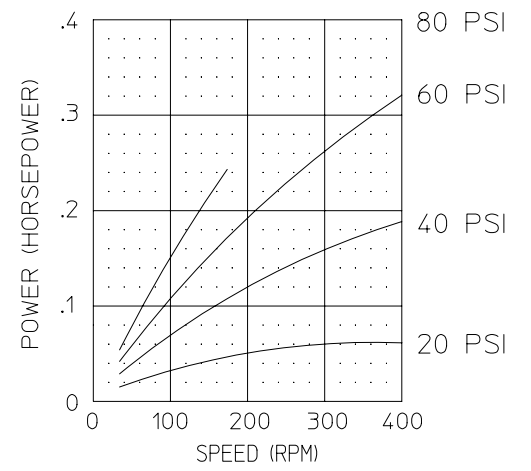
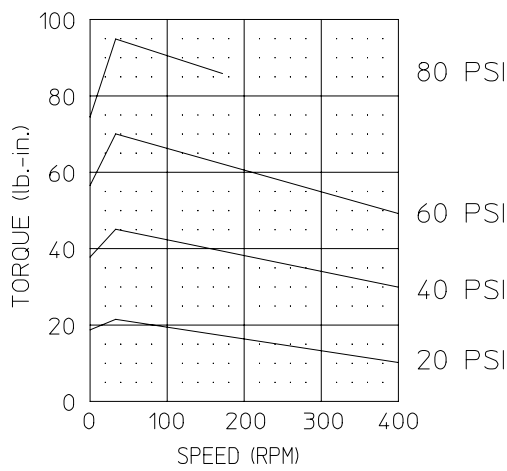
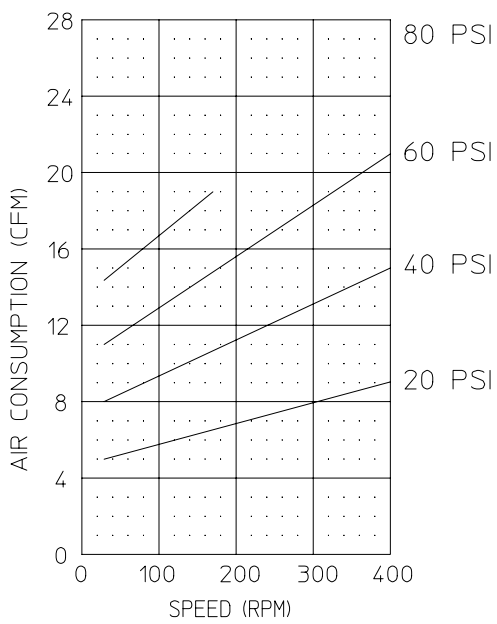
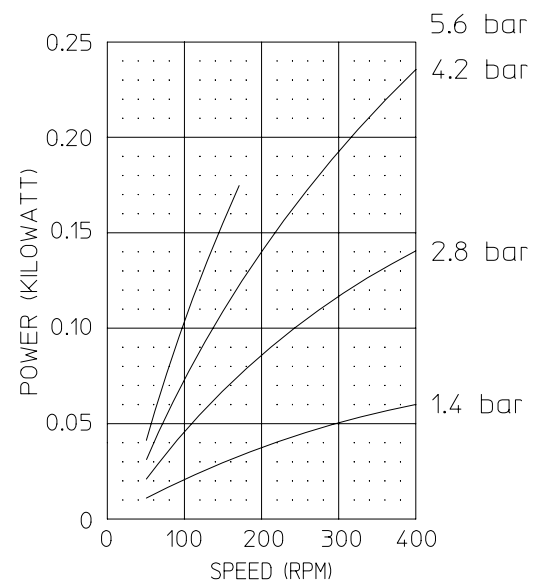
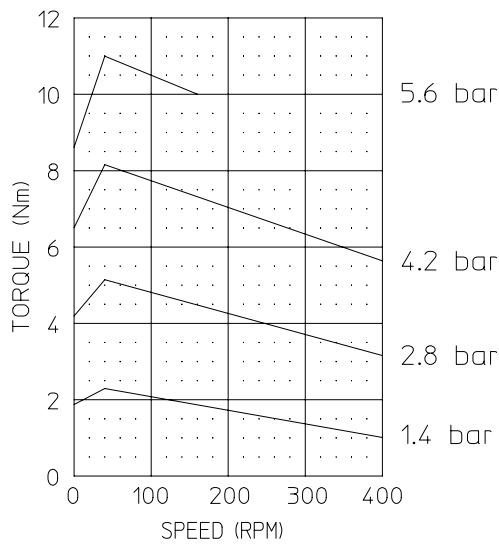
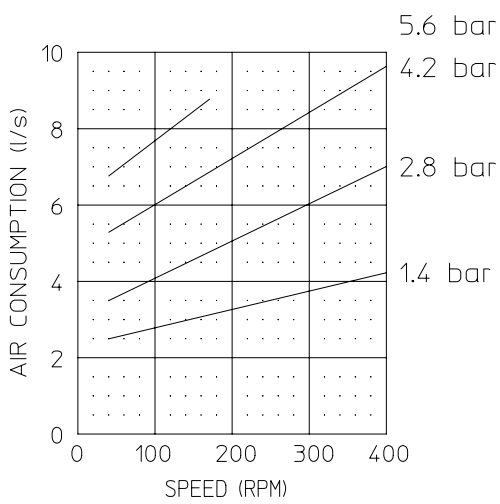

MUFFLER ASSEMBLY
 SHIPPED UNATTACHED
 (1UP-NRV-4A-GR11 EXCLUDED)

