



Model Number

RVI50N-09BA*6**

Incremental rotary encoder

Features

- **Sturdy and compact design**
- **Up to 2500 ppr**
- **5 V with RS-422 interface**

Description

The RVI50 is characterised by its small housing diameter of 50 mm with equal technical data compared to other encoder series.

The centering shoulder makes it possible to fit the unit very precisely. In addition to the three M3 holes, the encoder has a servo infeed on the circumference. This allows you to make a slight adjustment to the reference point of the incremental rotary encoder by turning the housing.

The clamping element that grips into the servo infeed ensures that the incremental rotary encoder stays firmly in place without slipping out of adjustment.

The pulse disk is designed in plastic up to 600 pulses. Beyond that, glass is used.

Technical data

General specifications

Detection type	photoelectric sampling
Pulse count	max. 2500

Electrical specifications

Operating voltage U_B	5 V DC \pm 5 %
No-load supply current I_0	max. 150 mA

Output

Output type	RS 422, incremental
Load current	max. per channel 20 mA , conditionally short-circuit proof
Output frequency	max. 160 kHz
Rise time	100 ns
De-energized delay t_{off}	100 ns

Connection

Connector	type 9416 (M23), 12-pin or type 42306 (M16), 6-pin
Cable	\varnothing 6 mm, 5 x 0.38 mm ² , 0.5 m

Standard conformity

Degree of protection	DIN EN 60529, IP50
Climatic testing	DIN EN 60068-2-78 , no moisture condensation
Emitted interference	EN 61000-6-4:2007/A1:2011
Noise immunity	EN 61000-6-2:2005
Shock resistance	DIN EN 60068-2-27, 100 g, 3 ms
Vibration resistance	DIN EN 60068-2-6, 10 g, 10 ... 2000 Hz

Ambient conditions

Operating temperature	
Glass disk	-20 ... 70 °C (-4 ... 158 °F)
Plastic disk	-20 ... 60 °C (-4 ... 140 °F)
Storage temperature	
Glass disk	-40 ... 70 °C (-40 ... 158 °F)
Plastic disk	-40 ... 60 °C (-40 ... 140 °F)

Mechanical specifications

Material	
Housing	powder coated aluminum
Flange	3.1645 aluminum
Shaft	Stainless steel 1.4305 / AISI 303
Mass	approx. 220 g
Rotational speed	max. 10000 min ⁻¹
Moment of inertia	\leq 5 gcm ²
Starting torque	\leq 1.5 Ncm
Shaft load	
Axial	30 N
Radial	50 N

Approvals and certificates

UL approval	cULus Listed, General Purpose, Class 2 Power Source
-------------	---

Dimensions

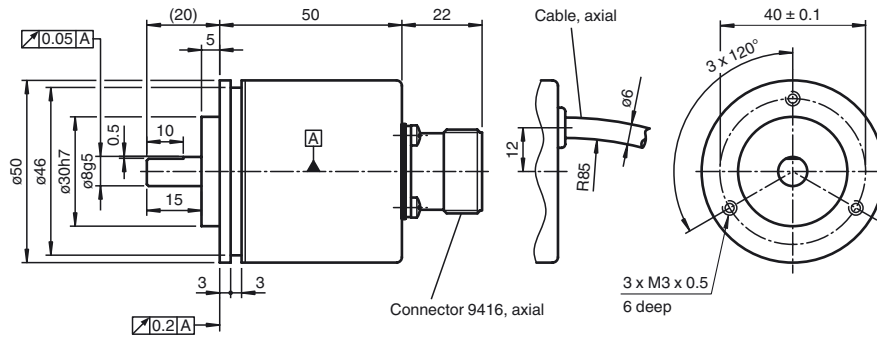

Clamping flange

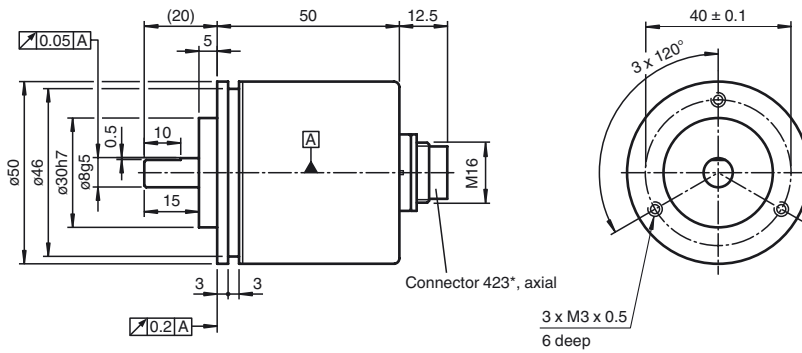

Clamping flange

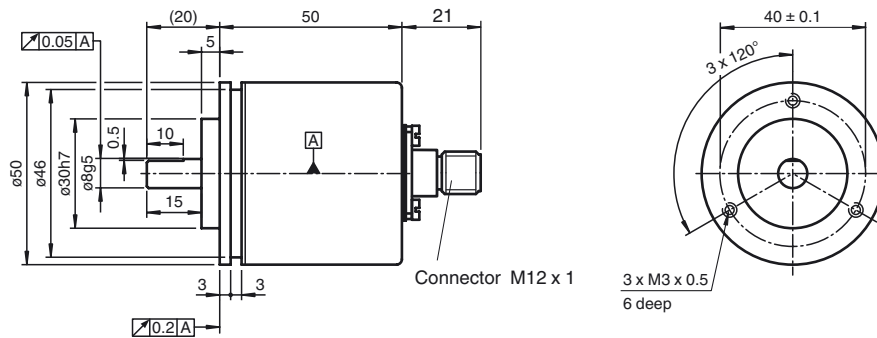

Clamping flange

Release date: 2018-10-31 07:55 Date of issue: 2018-10-31 t2336_eng.xml

Electrical connection

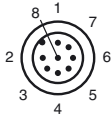
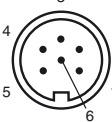
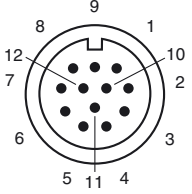
Signal	Cable Ø6 mm, 5-core	Connector M12 x 1, 8-pin	Connector 42306 (M16), 6-pin	Connector 9416 (M23), 12-pin
GND	Black	1	5	8
+U _b	Red	2	4	7
A	Green	3	1	1
B	White	5	2	3
\bar{A}	-	4	-	2
\bar{B}	-	6	-	4
0	Yellow	7	3	5
$\bar{0}$	-	8	-	6
Screen	-	Housing	Housing	Housing
				

Signal outputs

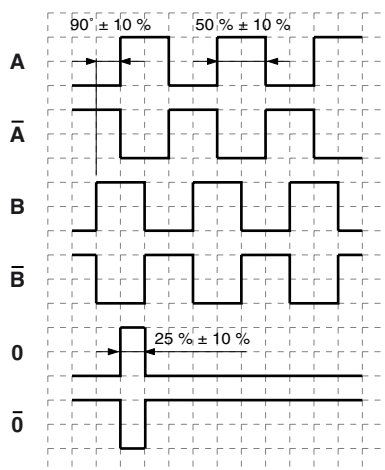

↻ cw - with view onto the shaft

Order code

R	V	I	5	0	N	-	0	9	B					N	-				
---	---	---	---	---	---	---	---	---	---	--	--	--	--	---	---	--	--	--	--

Pulse count 30, 60, 90, 100, 180, 200, 250, 300, 314, 360, 400, 500, 600, 720, 900, 1000, 1024, 1200, 1250, 1440, 1500, 1800, 2000, 2048, 2400, 2500

Option
N Normal

Connection type, cable exit, signal output, output switching

- ALA3T** Connector M16, type 42306, 6-pin, axial, A + B + 0, 4.75 V ... 30 V, push-pull
- AAA3T** Connector M23, type 9416, 12-pin, axial, A + B + 0, 4.75 V ... 30 V, push-pull
- AAA66** Connector M23, type 9416, 12-pin, axial, A + B + 0 and $\bar{A} + \bar{B} + \bar{0}$, 5 V, RS 422
- BEA66** Connector M12 x 1, 8-pin, axial, A + B + 0 and $\bar{A} + \bar{B} + \bar{0}$, 5 V, RS 422
- BEA3T** Connector M12 x 1, 8-pin, axial, A + B + 0, 4.75 V ... 30 V, push-pull
- K0A3T** Cable Ø6 mm, 5 x 0.38 mm², 0.5 m, axial, A + B + 0, 4.75 V ... 30 V, push-pull

Flange version
B Clamping flange

Shaft dimension
09 Shaft Ø8 mm x 15 mm

Housing material
N Aluminium, powder coated

Shaft version
V Solid shaft

Release date: 2018-10-31 07:55 Date of issue: 2018-10-31 t2336_eng.xml