



PC T5 COMBO Ip, 220 – 240 V 50/60 Hz

Linear fluorescent lamps

Product description

- Combination of electronic ballast and emergency lighting unit
- For T5 fluorescent lamps
- Low-profile casing (21 x 30 mm cross-section)
- For manual testing of the emergency lighting function
- 5-year guarantee

Properties

- Lightweight one-part emergency lighting unit
- Simple wiring
- No compatibility problems
- 1or 3 h rated duration
- Selectable operating time (jumper)
- Lamp warm start in normal operation
- Cathode heating in emergency mode
- AC operation of all lamps
- Automatic restart after relamping in normal operation
- Green charge status display LED
- Intelligent Voltage Guard (overvoltage indication and undervoltage shutdown)
- Optional test switch
- Checking the emergency lighting function by interrupting the unswitched phase
- IDC (insulation displacement connection)
- Electronically controlled battery charging
- Deep discharge protection
- Short-circuit-proof battery connection
- Polarity reversal protection for battery

Batteries

- High-temperature cells
- NiCd or NiMH batteries
- D, Cs or LA cells
- Blade terminals for simple connection
- 4-year design life
- 1-year guarantee
- For battery compatibility refer to chapter „Ballast-Lumen-Factor (BLF)“



Standards, page 7

Wiring diagrams and installation examples, page 10



PC T5 COMBO Ip, 220 – 240 V 50/60 Hz

Linear fluorescent lamps

Technical data

Rated supply voltage	220 – 240 V
Mains frequency	50 / 60 Hz
Mains voltage changeover threshold	according to EN 60598-2-22
Start time	~ 1.6 s
tc point max.	70 °C
tc point (PC 2x54-6 T5 COMBO Ip)	75 °C
Ambient temperature ta	0 ... 55 °C
Operating frequency (normal operation)	40 – 50 kHz
Operating frequency (emergency mode)	20 – 30 kHz
Overvoltage protection	320 V (for 1 h)
Battery charging time	24 h
Charge current 1 h	105 mA
Charge current 3 h	210 mA
Discharge current	11 A
Leakage current (PE)	< 0.5 mA
Min. lamp starting temperature (normal operation)	-15 °C
Min. lamp starting temperature (emergency mode)	0 °C
Type of protection	IP20

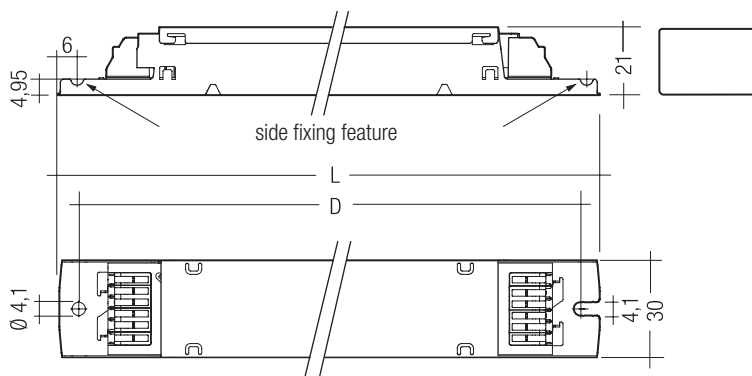

Ordering data

Type	Article number	Number of cells	Packaging, carton	Packaging, pallet	Weight per pc.
Rated operating time 3 / 1 h					
PC 1x14-3 T5 COMBO Ip	89899875	3	25 pc(s).	475 pc(s).	0.229 kg
PC 2x14-3 T5 COMBO Ip	89899876	3	25 pc(s).	475 pc(s).	0.229 kg
PC 1x21/28-5 T5 COMBO Ip	89899881	5	25 pc(s).	475 pc(s).	0.229 kg
PC 2x21/28-5 T5 COMBO Ip	89899882	5	25 pc(s).	475 pc(s).	0.229 kg
PC 1x24-4 T5 COMBO Ip	89899879	4	25 pc(s).	475 pc(s).	0.229 kg
PC 2x24-4 T5 COMBO Ip	89899880	4	25 pc(s).	475 pc(s).	0.229 kg
PC 1x35-6 T5 COMBO Ip	89899885	6	25 pc(s).	475 pc(s).	0.229 kg
PC 2x35-6 T5 COMBO Ip	89899886	6	25 pc(s).	475 pc(s).	0.229 kg
PC 1x39-5 T5 COMBO Ip	89899883	5	25 pc(s).	475 pc(s).	0.229 kg
PC 2x39-5 T5 COMBO Ip	89899884	5	25 pc(s).	475 pc(s).	0.229 kg
PC 1x49-5 T5 COMBO Ip	89899887	5	25 pc(s).	475 pc(s).	0.229 kg
PC 2x49-5 T5 COMBO Ip	89899888	5	25 pc(s).	475 pc(s).	0.340 kg
PC 1x54-6 T5 COMBO Ip	89899889	6	25 pc(s).	475 pc(s).	0.229 kg
PC 2x54-6 T5 COMBO Ip	89899890	6	25 pc(s).	475 pc(s).	0.334 kg
PC 1x80-6 T5 COMBO Ip	89899891	6	25 pc(s).	475 pc(s).	0.229 kg

Specific technical data

Lamp type	Lamp wattage	Type	Article number	Dimensions L x W x H	Hole spacing D	Lamp power	Circuit power	Mains current	λ	Normal operation BLF	Emergency operation BLF	Emergency operation EBLF ^①	Rated duration
Rated operating time 3 / 1 h													
T5	1 x 14 W	PC 1x14-3 T5 COMBO Ip	89899875	425 x 30 x 21 mm	415 mm	14.4 W	19.4 W	0.090 A	0.96	1	0.170	0.170	3 / 1 h
T5	2 x 14 W	PC 2x14-3 T5 COMBO Ip	89899876	425 x 30 x 21 mm	415 mm	28.8 W	35.0 W	0.160 A	0.95	1	0.170	0.170	3 / 1 h
T5	1 x 21 W	PC 1x21/28-5 T5 COMBO Ip	89899881	425 x 30 x 21 mm	415 mm	20.5 W	28.8 W	0.130 A	0.95	1	0.120	0.115	3 / 1 h
T5	1 x 28 W	PC 1x21/28-5 T5 COMBO Ip	89899881	425 x 30 x 21 mm	415 mm	27.9 W	35.9 W	0.160 A	0.97	1	0.120	0.095	3 / 1 h
T5	2 x 21 W	PC 2x21/28-5 T5 COMBO Ip	89899882	425 x 30 x 21 mm	415 mm	40.9 W	50.0 W	0.225 A	0.97	1	0.120	0.110	3 / 1 h
T5	2 x 28 W	PC 2x21/28-5 T5 COMBO Ip	89899882	425 x 30 x 21 mm	415 mm	55.8 W	66.5 W	0.295 A	0.98	1	0.120	0.095	3 / 1 h
T5	1 x 24 W	PC 1x24-4 T5 COMBO Ip	89899879	425 x 30 x 21 mm	415 mm	22.2 W	29.9 W	0.135 A	0.95	1	0.130	0.127	3 / 1 h
T5	2 x 24 W	PC 2x24-4 T5 COMBO Ip	89899880	425 x 30 x 21 mm	415 mm	43.0 W	54.7 W	0.245 A	0.97	1	0.130	0.127	3 / 1 h
T5	1 x 35 W	PC 1x35-6 T5 COMBO Ip	89899885	425 x 30 x 21 mm	415 mm	35.7 W	44.5 W	0.200 A	0.98	1	0.130	0.075	3 / 1 h
T5	2 x 35 W	PC 2x35-6 T5 COMBO Ip	89899886	425 x 30 x 21 mm	415 mm	71.4 W	84.4 W	0.370 A	0.98	1	0.130	0.075	3 / 1 h
T5	1 x 39 W	PC 1x39-5 T5 COMBO Ip	89899883	425 x 30 x 21 mm	415 mm	40.0 W	47.0 W	0.210 A	0.97	1	0.070	0.065	3 / 1 h
T5	2 x 39 W	PC 2x39-5 T5 COMBO Ip	89899884	425 x 30 x 21 mm	415 mm	77.0 W	88.0 W	0.390 A	0.98	1	0.070	0.065	3 / 1 h
T5	1 x 49 W	PC 1x49-5 T5 COMBO Ip	89899887	425 x 30 x 21 mm	415 mm	50.0 W	58.2 W	0.260 A	0.98	1	0.060	0.050	3 / 1 h
T5	2 x 49 W	PC 2x49-5 T5 COMBO Ip	89899888	425 x 30 x 21 mm	415 mm	101.4 W	112.0 W	0.500 A	0.99	1	0.070	0.050	3 / 1 h
T5	1 x 54 W	PC 1x54-6 T5 COMBO Ip	89899889	425 x 30 x 21 mm	415 mm	54.8 W	66.9 W	0.300 A	0.97	1	0.060	0.040	3 / 1 h
T5	2 x 54 W	PC 2x54-6 T5 COMBO Ip	89899890	425 x 30 x 21 mm	415 mm	105.0 W	120.3 W	0.530 A	0.99	1	0.060	0.040	3 / 1 h
T5	1 x 80 W	PC 1x80-6 T5 COMBO Ip	89899891	425 x 30 x 21 mm	415 mm	79.5 W	87.3 W	0.385 A	0.98	1	0.048	0.043	3 / 1 h

^① According to EN 61347-2-7

RoHS

ACCES-
SORIES

Status indication green LED

Product description

- A green LED indicates that charging current is flowing into the battery



Ordering data

Type	Article number	Packaging		Weight per pc.
		bag	carton	
LED EM green	89899605	25 pc(s).	200 pc(s).	0.017 kg
LED EM green, ultra high brightness	89899756	25 pc(s).	200 pc(s).	0.012 kg

RoHS

ACCES-
SORIES

Test switch EM3

Product description

- For connection to the emergency lighting unit
- For checking the device function



Ordering data

Type	Article number	Packaging		Weight per pc.
		bag	carton	
Test switch EM 3	89899956	25 pc(s).	200 pc(s).	0.013 kg

Ballast lumen factor (BLF) in %

PC T5 COMBO Ip for T5 fluorescent lamps, 3 or 1h

	Duration	3 h or 1 h					
		3 cells		5 cells		4 cells	
Cells							
Type		PC 1x14 – 3 T5 COMBO Ip	PC 2x14 – 3 T5 COMBO Ip	PC 1x21/28 – 5 T5 COMBO Ip	PC 2x21/28 – 5 T5 COMBO Ip	PC 1x24 – 4 T5 COMBO Ip	PC 2x24 – 4 T5 COMBO Ip
Article no.		89899875	89899876	89899881	89899882	89899879	89899880
Lamp type	Wattage	BLF in emergency lighting mode in % for rated operating time					
T5	14 W	17	17				
	21 W			12	12		
	24 W					13	13
	28 W			12	12		
	35 W						
	39 W						
	49 W						
	54 W						
	80 W						

Technology and capacity	Design	Number of cells	Type	Article number	Assignable batteries			
NiCd 1.6 Ah Cs cells	Stick	3	Accu-NiCd C 3A	89899743	•	•		
	Stick	4	Accu-NiCd C 4A	89899692			•	•
	Stick	5	Accu-NiCd C 5A	89899695		•	•	
	Stick	6	Accu-NiCd C 6A	89899698				
	Stick + Stick	3+3	Accu-NiCd C 6C	89899699				
NiCd 4 Ah D cells	Stick	3	Accu-NiCd 3A	89895960	•	•		
	Stick	4	Accu-NiCd 4A 55	89800089			•	•
	Stick	5	Accu-NiCd 5A	89895973		•	•	
	Stick + Stick	2+3	Accu-NiCd 5C 55	89800090		•	•	
	Stick + Stick	3+3	Accu-NiCd 6C 55	89800388				
NiMH 2 Ah Cs cells	Stick	3	Accu-NiMH C 3A	89899744	•	•		
	Stick	4	Accu-NiMH C 4A	89899700			•	•
	Stick	5	Accu-NiMH C 5A	89899703		•	•	
	Stick	6	Accu-NiMH C 6A	89899706				
	Stick + Stick	3+3	Accu-NiMH C 6C	89899707				
NiMH 4 Ah LA cells	Stick	3	Accu-NiMH 4Ah 3A CON	89800441	•	•		
	Stick	4	Accu-NiMH 4Ah 4A CON	89800442			•	•
	Stick + Stick	2+2	Accu-NiMH 4Ah 4C CON	89800438			•	•
	Stick + Stick	2+3	Accu-NiMH 4Ah 5C CON	89800439		•	•	
	Stick + Stick	3+3	Accu-NiMH 4Ah 6C CON	89800440				
NiMH 2.2Ah Cs cells	remote box	1 x 3	Pack-NiMH 2.2Ah 3 CON	28001898	•	•		
	remote box	1 x 4	Pack-NiMH 2.2Ah 4 CON	28001899			•	•
NiMH 4 Ah LAL cells	remote box	1 x 3	Pack-NiMH 4Ah 3 CON	28001896	•	•		
	remote box	1 x 4	Pack-NiMH 4Ah 4 CON	28001897			•	•

For 3-hour operation: 4 Ah D cells NiCd or 4 Ah LA cells NiMH.

For 1-hour operation: 1.6 Ah Cs cells NiCd or 2 Ah Cs cells NiMH.

Ballast lumen factor (BLF) in %

PC T5 COMBO Ip for T5 fluorescent lamps, 3 or 1 h

Duration	3 h or 1 h				
	6 cells	6 cells	5 cells	5 cells	5 cells
Cells	6 cells	6 cells	5 cells	5 cells	5 cells
Type	PC 1x35 – 6 T5 COMBO Ip	PC 2x35 – 6 T5 COMBO Ip	PC 1x39 – 5 T5 COMBO Ip	PC 2x39 – 5 T5 COMBO Ip	PC 1x49 – 5 T5 COMBO Ip
Article no.	89899885	89899886	89899883	89899884	89899887
Lamp type	Wattage	BLF in emergency lighting mode in % for rated operating time			
T5	14 W				
	21 W				
	24 W				
	28 W				
	35 W	13	13		
	39 W			7	7
	49 W				6
	54 W				
	80 W				

Technology and capacity	Design	Number of cells	Type	Article number	Assignable batteries				
NiCd 1.6 Ah Cs cells	Stick	3	Accu-NiCd C 3A	89899743					
	Stick	4	Accu-NiCd C 4A	89899692					
	Stick	5	Accu-NiCd C 5A	89899695			•	•	•
	Stick	6	Accu-NiCd C 6A	89899698	•	•			
	Stick + Stick	3 + 3	Accu-NiCd C 6C	89899699	•	•			
NiCd 4 Ah D cells	Stick	3	Accu-NiCd 3A	89895960					
	Stick	4	Accu-NiCd 4A 55	89800089					
	Stick	5	Accu-NiCd 5A	89895973			•	•	•
	Stick + Stick	3 + 2	Accu-NiCd 5C 55	89800090			•	•	•
	Stick + Stick	3 + 3	Accu-NiCd 6C 55	89800388	•	•			
NiMH 2 Ah Cs cells	Stick	3	Accu-NiMH C 3A	89899744					
	Stick	4	Accu-NiMH C 4A	89899700					
	Stick	5	Accu-NiMH C 5A	89899703			•	•	•
	Stick	6	Accu-NiMH C 6A	89899706	•	•			
	Stick + Stick	3 + 3	Accu-NiMH C 6C	89899707	•	•			
NiMH 4 Ah LA cells	Stick	3	Accu-NiMH 4Ah 3A CON	89800441					
	Stick	4	Accu-NiMH 4Ah 4A CON	89800442					
	Stick + Stick	2 + 2	Accu-NiMH 4Ah 4C CON	89800438					
	Stick + Stick	2 + 3	Accu-NiMH 4Ah 5C CON	89800439			•	•	•
	Stick + Stick	3 + 3	Accu-NiMH 4Ah 6C CON	89800440	•	•			
NiMH 2.2 Ah Cs cells	remote box	1 x 3	Pack-NiMH 2.2Ah 3 CON	28001898					
	remote box	1 x 4	Pack-NiMH 2.2Ah 4 CON	28001899					
NiMH 4 Ah LAL cells	remote box	1 x 3	Pack-NiMH 4Ah 3 CON	28001896					
	remote box	1 x 4	Pack-NiMH 4Ah 4 CON	28001897					

For 3-hour operation: 4 Ah D cells NiCd or 4 Ah LA cells NiMH.

For 1-hour operation: 1.6 Ah Cs cells NiCd or 2 Ah Cs cells NiMH.

Ballast lumen factor (BLF) in %

PC T5 COMBO Ip for T5 fluorescent lamps, 3 or 1 h

	Duration	3 h or 1 h			
		5 cells	6 cells	6 cells	6 cells
Cells		5 cells	6 cells	6 cells	6 cells
Type		PC 2x49 – 5 T5 COMBO Ip	PC 1x54 – 6 T5 COMBO Ip	PC 2x54 – 6 T5 COMBO Ip	PC 1x80 – 6 T5 COMBO Ip
Article no.		89899888	89899889	89899890	89899891
Lamp type	Wattage	BLF in emergency lighting mode in % for rated operating time			
T5	14 W				
	21 W				
	24 W				
	28 W				
	35 W				
	39 W				
	49 W	7			
	54 W		6	6	
	80 W				4.8

Technology and capacity	Design	Number of cells	Type	Article number	Assignable batteries			
NiCd 1.6 Ah Cs cells	Stick	3	Accu-NiCd C 3A	89899743				
	Stick	4	Accu-NiCd C 4A	89899692				
	Stick	5	Accu-NiCd C 5A	89899695	•			
	Stick	6	Accu-NiCd C 6A	89899698		•	•	•
	Stick + Stick	3+3	Accu-NiCd C 6C	89899699		•	•	•
NiCd 4 Ah D cells	Stick	3	Accu-NiCd 3A	89895960				
	Stick	4	Accu-NiCd 4A 55	89800089				
	Stick	5	Accu-NiCd 5A	89895973	•			
	Stick + Stick	3+2	Accu-NiCd 5C 55	89800090	•			
	Stick + Stick	3+3	Accu-NiCd 6C 55	89800388		•	•	•
NiMH 2 Ah Cs cells	Stick	3	Accu-NiMH C 3A	89899744				
	Stick	4	Accu-NiMH C 4A	89899700				
	Stick	5	Accu-NiMH C 5A	89899703	•			
	Stick	6	Accu-NiMH C 6A	89899706		•	•	•
	Stick + Stick	3+3	Accu-NiMH C 6C	89899707		•	•	•
NiMH 4 Ah LA cells	Stick	3	Accu-NiMH 4Ah 3A CON	89800441				
	Stick	4	Accu-NiMH 4Ah 4A CON	89800442				
	Stick + Stick	2+2	Accu-NiMH 4Ah 4C CON	89800438				
	Stick + Stick	2+3	Accu-NiMH 4Ah 5C CON	89800439	•			
	Stick + Stick	3+3	Accu-NiMH 4Ah 6C CON	89800440		•	•	•
NiMH 2.2Ah Cs cells	remote box	1 x 3	Pack-NiMH 2.2Ah 3 CON	28001898				
	remote box	1 x 4	Pack-NiMH 2.2Ah 4 CON	28001899				
NiMH 4 Ah LAL cells	remote box	1 x 3	Pack-NiMH 4Ah 3 CON	28001896				
	remote box	1 x 4	Pack-NiMH 4Ah 4 CON	28001897				

For 3-hour operation: 4 Ah D cells NiCd or 4 Ah LA cells NiMH.

For 1-hour operation: 1.6 Ah Cs cells NiCd or 2 Ah Cs cells NiMH.

Standards

- according to EN 50172
- according to 60598-2-22
- EN 61347-2-3
- EN 61347-2-7
- EN 60929
- EN 55015
- EN 61000-3-2
- EN 61000-3-3
- EN 61547
- EN 60068-2-29
- EN 60068-2-30
- EN 60068-2-64
- Mains ballast complies with end of lamp life (EOL) test 2



Note:

The PC T5 COMBO Ip is not intended to be used for high risk task area lighting.

Isolation and electric strength testing of luminaires

Electronic devices can be damaged by high voltage. This has to be considered during the routine testing of the luminaires in production.

According to IEC 60598-1 Annex Q (informative only!) or ENEC 303-Annex A, each luminaire should be submitted to an isolation test with 500 VDC for 1 second. This test voltage should be connected between the interconnected phase and neutral terminals and the earth terminal. The isolation resistance must be at least 2 MΩ.

As an alternative, IEC 60598-1 Annex Q describes a test of the electrical strength with 1,500 VAC (or 1,414 x 1,500 VDC). To avoid damage to the electronic devices this test must not be conducted.

Basic insulation between supply and battery circuit

Restarting after lamp replacement

Note: Before servicing luminaires the mains supply should always be disconnected.

If faulty lamps are changed with the mains connected they can be made to restart automatically provided an interval of 2 seconds is left after removal.

- Single lamp combined units always restart automatically.
- Twin lamp combined units that do not restart automatically will do so if the first lamp that was inserted is removed and re-inserted.

Working voltage (Uout), THD, lamp current

Type	Lamp type	Wattage	Uout [Ⓢ]	THD at 230 V, 50 Hz, maintained mode	Lamp current [Ⓢ]
PC 1/14 – 3 T5 COMBO Ip	T5	1x14 W	400 / 400 V	≤ 20	0.027 A
PC 2/14 – 3 T5 COMBO Ip	T5	2x14 W	300 / 300 V	≤ 15	0.027 A
PC 1/21/28 – 5 T5 COMBO Ip	T5	1x21/28 W	400 / 400 V	≤ 15	0.017 A
PC 2/21/28 – 5 T5 COMBO Ip	T5	2x21/28 W	300 / 300 V	≤ 15	0.017 A
PC 1/24 – 4 T5 COMBO Ip	T5	1x24 W	250 / 250 V	≤ 20	0.027 A
PC 2/24 – 4 T5 COMBO Ip	T5	2x24 W	400 / 400 V	≤ 15	0.027 A
PC 1/35 – 6 T5 COMBO Ip	T5	1x35 W	400 / 400 V	≤ 15	0.016 A
PC 2/35 – 6 T5 COMBO Ip	T5	2x35 W	380 / 320 V	≤ 15	0.016 A
PC 1/39 – 5 T5 COMBO Ip	T5	1x39 W	250 / 250 V	≤ 20	0.015 A
PC 2/39 – 5 T5 COMBO Ip	T5	2x39 W	250 / 250 V	≤ 15	0.015 A
PC 1/49 – 5 T5 COMBO Ip	T5	1x49 W	390 / 350 V	≤ 15	0.011 A
PC 2/49 – 5 T5 COMBO Ip	T5	2x49 W	390 / 350 V	≤ 10	0.013 A
PC 1/54 – 6 T5 COMBO Ip	T5	1x54 W	270 / 270 V	≤ 15	0.014 A
PC 2/54 – 6 T5 COMBO Ip	T5	2x54 W	270 / 270 V	≤ 15	0.014 A
PC 1/80 – 6 T5 COMBO Ip	T5	1x80 W	340 / 320 V	≤ 15	0.012 A

[Ⓢ] In emergency operation

[Ⓢ] Max. voltage between output terminals / Max. voltage between output terminal to earth

Technical data batteries

Accu-NiCd

1.6 Ah

Battery voltage/cell	1.2 V
Cell type	Cs
Case temperature range to ensure 4 years design life	+5 °C to +50 °C
Max. short term temperature (reduced life-time)	70 °C
Max. number discharge cycles	4 cycles per year plus 4 cycles during commissioning
Max. storage time	6 months

4.2 / 4.5 Ah

Battery voltage/cell	1.2 V
Cell type	D
Case temperature range to ensure 4 years design life	+5 °C to +55 °C
Max. short term temperature (reduced life-time)	70 °C
Max. number discharge cycles	4 cycles per year plus 4 cycles during commissioning
Max. storage time	6 months

Accu-NiMH

2.0 Ah

Battery voltage/cell	1.2 V
Cell type	Cs
Case temperature range to ensure 4 years design life	+5 °C to +55 °C
Max. short term temperature (reduced life-time)	70 °C
Max. number discharge cycles	4 cycles per year plus 30 cycles during commissioning
Max. storage time	6 months

4.0 Ah

Battery voltage/cell	1.2 V
Cell type	LA
Case temperature range to ensure 4 years design life	+5 °C to +40 °C
Max. short term temperature (reduced life-time)	70 °C
Max. number discharge cycles	4 cycles per year plus 30 cycles during commissioning
Max. storage time	6 months

Accupack-NiMH

2.2 Ah

Battery voltage/cell	1.2 V
Cell type	Cs
Ambient temperature range to ensure 4 years design life	+5 °C to +35 °C
tc point	+40 °C
Max. short term temperature (reduced life-time)	70 °C
Max. number discharge cycles	4 cycles per year plus 4 cycles during commissioning
Max. storage time	6 months

4.0 Ah

Battery voltage/cell	1.2 V
Cell type	LAL
Ambient temperature range to ensure 4 years design life tc point	+5 °C to +35 °C +40 °C
Max. short term temperature (reduced life-time)	70 °C
Max. number discharge cycles	4 cycles per year plus 4 cycles during commissioning
Max. storage time	6 months

For further information refer to corresponding battery datasheet.

Storage, installation and commissioning

Relevant information about storage conditions, installation and commissioning are provided in the battery datasheets.



Care should be taken to ensure batteries and emergency units don't exceed their maximum temperatures.

Intelligent Voltage Guard

Intelligent Voltage Guard is the name of the new electronic monitor from Tridonic. This innovative feature of the new PC COMBO family of combined electronic ballasts and emergency lighting modules from Tridonic immediately shows if the mains voltage rises above a certain threshold. Measures can then be taken quickly to prevent damage to the control gear. If the mains voltage rises above 306 V the lamps start flashing on and off. This signal "demands" disconnection of the power supply to the lighting system.

New PC COMBO with xitec processor

Is the very latest in lighting management design technology. The lamp friendly warm start is delivering maximum lamp life and enables high switching frequency applications. Smallest power loss and new freedom in the lamp design thanks to convincing thermal management.

Energy class CELMA EEI = A2

PC T5 COMBO Ip ignition technology (smart heating) optimises lamp start and ensures no energy is wasted. After the lamp has struck the filament heating is reduced automatically to a defined minimum value. This reduction in filament heating, saves energy, yet maintains the proper operating conditions for the lamp. The lamp is always operated within specification.

Smart Heating (normal operation)

Innovative heating circuit. Reduced filament heating after lamp has struck.

Ambient Temperature

PC T5 COMBO Ip

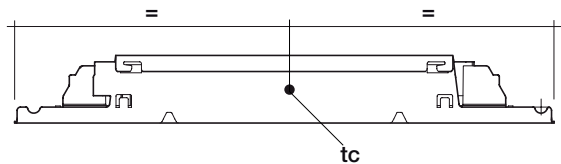

The nominal t_a and t_c point are related to the ballast life duration. The relation of t_c to t_a temperature depends also on the luminaire design. If the measured t_c temperature is approx. 5 K below t_c max., t_a temperature should be checked and eventually critical components (e.g. ELCAP) measured. Detailed information on request.

Life-time

PC T5 COMBO Ip is designed for an average life-time of 50,000 hours under reference conditions and with a failure probability of less than 10 %. This corresponds to an average failure rate of 0.2 % for every 1,000 hours of operation.

CE marking

The PC T5 COMBO Ip units are CE marked for compliance with the low voltage directive.

Certificates of compliance are available to allow luminaires to be CE marked for compliance with the EMC directive.

Mechanical details

Channel and Cover manufactured from 0.4 mm white precoated steel.

LED charge indicator

- Green
- Mounting hole 6.5 mm dia
- Length of LED lead 750 mm (Bezel supplied fitted to LED)
- Insulation temperature rating: 90 °C

Test switch

- Mounting hole 7 mm dia
- Length of test switch lead 550 mm

Battery leads

- Quantity: 1 red and 1 black
- Length: 1300 mm
- Wire type: 0.5 mm² solid conductor
- Insulation temperature rating: 90 °C

Termination 1

Push on 4.8 mm receptacle to suit battery spade fitted with insulating cover

Termination 2

9 mm stripped insulation

Side fixing feature

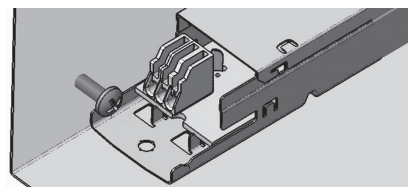

Screw M4, screw head diameter 8–10 mm

Jumper selection:

3 hours operation as supplied for use with 4 Ah NiCd D or 4 Ah NiMH Cs cells.

Remove the jumper for 1 hour operation and use with Cs 1.5 Ah NiCd or 2.0 Ah NiMh cells.

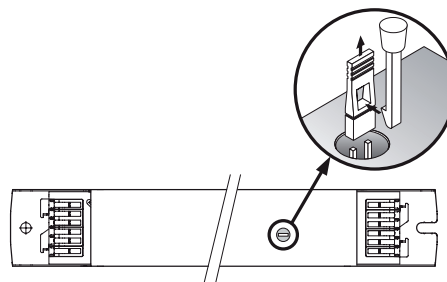

Electrical connections

In low temperature applications an starting aid is required for the emergency lamp which is referenced to the metal case of the unit. This starting aid does not need to be earthed.

The combined unit is intended to be earthed by the Ⓧ marked terminal connection.

Two phases can be used as switched and unswitched line.

Note:

All electrical connections to the unit must be made when both permanent and switched mains supplies are disconnected

Batteries

Connection method: 4.8 x 0.5 mm spade welded to end of cell

For the stick batteries this connection is accessible after the battery end caps have been fitted.

To inhibit inverter operation, only disconnect the batteries by removing the connector from the battery spade tags.

Note:

The battery charger of the PC T5 Combo Ip is short circuit protected. After a battery short circuit the protection device will be resetted after a short while.

Battery must not be connected to earth.

Storage

It is recommended to disconnect the battery before store or delivery. A long term storage in open circuit leads to battery self discharge and deactivation of chemical components. It could be required to charge and discharge the batteries a few times to recover the initial performance.

Wiring advice

The lead length is dependant on the capacitance of the cable.

For safety reasons, the PC T5 COMBO Ip must only be earthed in the case of a safety class 1 luminaire. Earthing is not required for the device to operate. Connection to earth reduces radio interference

Ballast Type	Terminal		Maximum lead capacitance allowed	
	Cold	Hot	Cold	Hot
PC 1xx T5 COMBO Ip	3, 4	1, 2	200 pF	100 pF
PC 2xx T5 COMBO Ip	3, 4, 5, 6	1, 2, 7, 8	200 pF	100 pF
PC 2/35 T5 COMBO Ip	3, 4, 5, 6	1, 2, 7, 8	100 pF	50 pF
PC 2/49 T5 COMBO Ip	3, 4, 5, 6	1, 2, 7, 8	100 pF	50 pF

IDC interface

- Solid wire with a cross section of 0.5 mm² according to the specification from WAGO
- Alternatively a flexible lead with a cross section of 0.75 mm²

Horizontal interface

- Solid wire with a cross section of 0.5–0.75 mm² according to the specification from WAGO
- Solid wire with a cross section of 1.0 mm² with an insulation diameter up to 2.5 mm
- Strip 9 mm of insulation from the cables to ensure perfect operation of the terminals
- Loosen wire through twisting and pulling

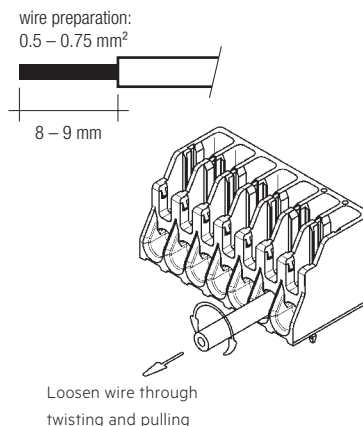

RFI

Tridonic ballasts are RFI protected in accordance with EN 55015.

To operate the luminaire correctly and to minimise RFI we recommend the following instructions:

- Connection to the lamps of the “hot leads” must be kept as short as possible (marked with *)
- Mains leads should be kept apart from lamp leads (ideally 5–10 cm distance)
- Do not run mains leads adjacent to the electronic ballast
- Twist the lamp leads
- Keep the distance of lamp leads from the metal work as large as possible
- Ballast should be earthed, over the terminal.
- Mains wiring to be twisted when through wiring
- Keep the mains leads inside the luminaire as short as possible

With standard solid wire 0.5/0.75 mm² the capacitance of the lead is 30–80 pF/m. This value is influenced by the way the wiring is made.

- keep lamp wires short
- lamp connection with multi-lamp ballasts should be made with symmetrical wiring
- for 1 and 2 lamp ballasts: hot leads 1,2,7,8 and cold leads 3,4,5,6 should be separated as much as possible
- The LED, test switch and battery wiring should be routed separately and kept as far away as possible from the high frequency lamp leads to avoid coupling.

PC T5 COMBO Ip wiring diagrams

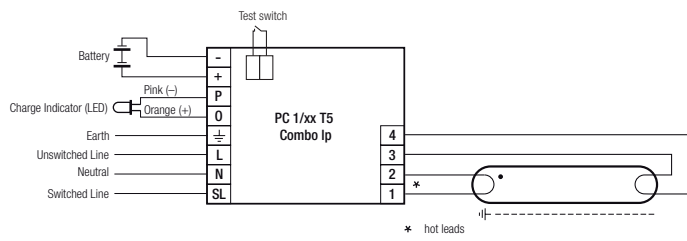

Wiring diagram PC T5 COMBO Ip with single T5 lamp

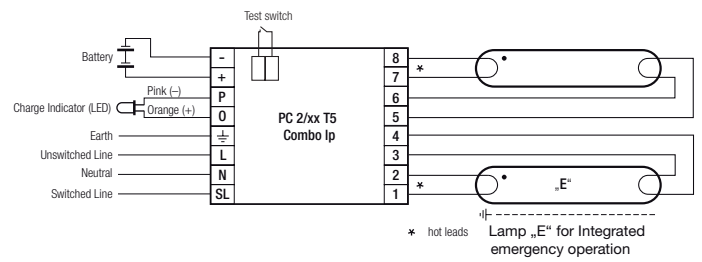

Wiring diagram PC T5 COMBO Ip with twin T5 lamp

Additional information

Additional technical information at www.tridonic.com → Technical Data

Guarantee conditions at www.tridonic.com → Services

Life-time declarations are informative and represent no warranty claim.
No warranty if device was opened.