

**Hahn Part Number : G14-28ST#25188**  
**G 14 28 0400 1 0950 AU27 AB16 01300N**

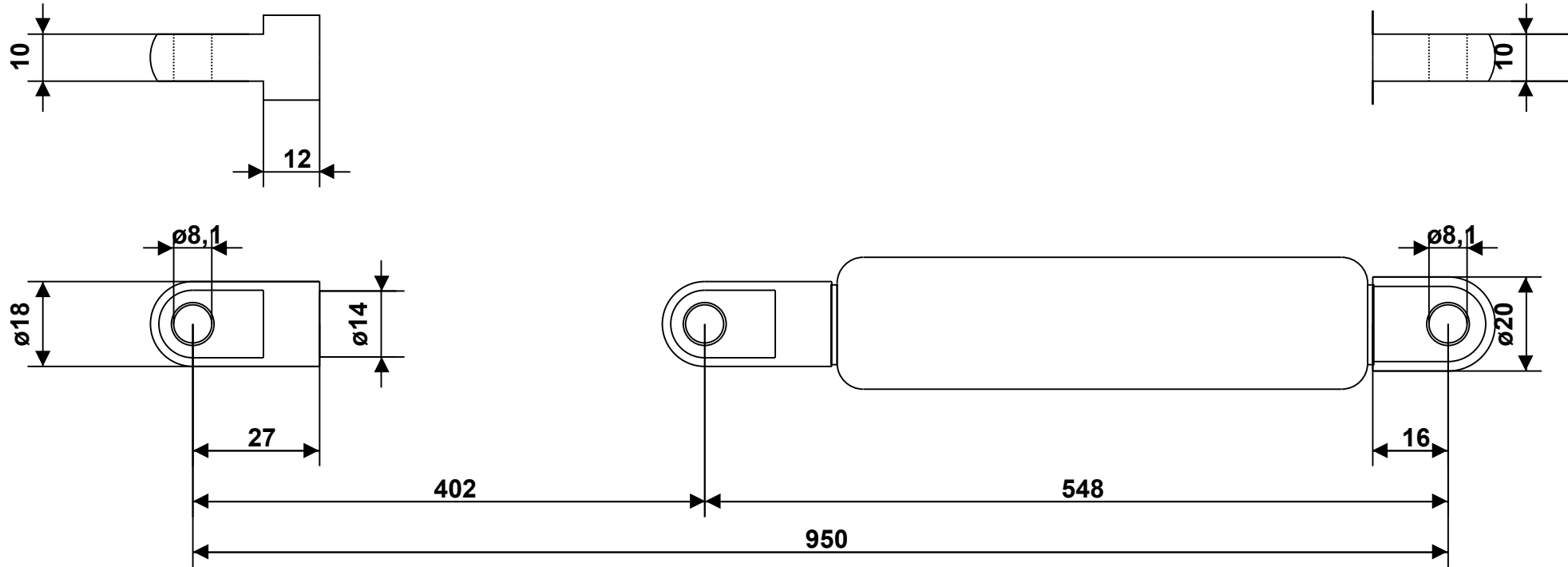

Intended for internal use and customer / Tolerance of ext. length: +/- 2mm - Dimensions without tolerance: per DIN ISO 2768-1 -c (ISO 2768 -c) - For Information Only  
 Force tolerance: F1 >= 1000N: +/- 5%; < 1000N: +/- 10%, min.: +/- 10N, max.: +/- 50N - Unregistered Copy, Print-out or file not subject to modification service.  
 End fitting orientation is random and not represented by drawing unless specified - Observe disposal instructions - Not true to scale



Please note our technical instructions

Assembly/storing with piston rod down

13. Feb 2020

Auto-Printservice

No opening-no heating-high pressure

Made in Germany

Part

Dimension

Material / Surface

Fitting

Progr.:45,10 %

Drawing owned by Hahn Gasfedern GmbH

Piston rod

Ø14mm

steel, chrome plated

AU27 M10 Ø8.1 t=10 \* ANS/M10/AUG/001

info@hahn-gasfedern.de

Cylinder

Ø28mm

Stahl,black

AB16 Ø8,1 t=10 \* BG/28/AUG/001

www.hahn-gasfedern.de

Configuration ID : 10040187-