

2/2, 3/2 and 4/2 directional seat valve with solenoid actuation

RE 22049/07.09
Replaces: 07.06

1/14

Type M-.SED

Size 6
Component series 1X
Maximum operating pressure 350 bar [5100 psi]
Maximum flow 25 l/min [6.6 gpm]



H4243

Table of contents

Contents	Page
Features	1
Ordering code	2, 3
Function, section, symbols	4, 5
Technical data	6
Characteristic curves	7
Performance limit	8
Unit dimensions	9 to 12
Valve mounting screws	13
Mating connectors	13
Throttle insert	14
Check valve insert	14
General notes	14

Features

- Direct operated directional seat valve with solenoid actuation
- Porting pattern according to DIN 24340 form A (**without** locating hole)
- Porting pattern according to ISO 4401-03-02-0-05 and NFPA T3.5.1 R2-2002 D03 (**with** locating hole)
- Safe switching also with longer standstill periods under pressure
- Wet-pin DC voltage solenoids with detachable coil (AC voltage possible by means of a rectifier)
- Solenoid coil can be rotated by 90°
- The coil can be changed without having to open the pressure-tight chamber
- Electrical connection as individual connection (for more electrical connections, see RE 08010)
- With concealed manual override, optional
- Inductive position switch (contactless), see RE 24830

Information on available spare parts:
www.boschrexroth.com/spc

Ordering code

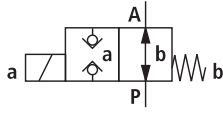
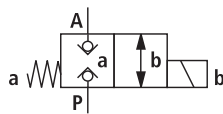
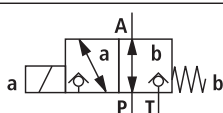
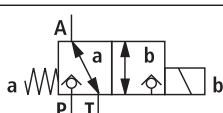
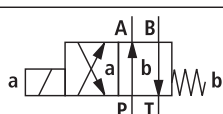
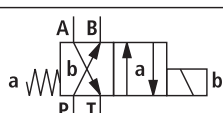
					M	SED	6	-1X/350	C	
2 main ports					= 2					
3 main ports					= 3					
4 main ports					= 4					
Seat valve										
Size 6					= 6					
Symbols	Main ports	2	3	4						
		●	-	-	= PK					
		●	-	-	= NK					
		-	●	-	= UK					
		-	●	-	= CK					
		-	-	●	= D					
		-	-	●	= Y					
					● = Available					
Component series 10 to 19 (10 to 19: unchanged installation and connection dimensions)					= 1X					
Operating pressure 350 bar [5100 psi]					= 350					
Solenoid, wet-pin with detachable coil					= C					
DC voltage 24 V					= G24					
DC voltage 205 V					= G205 ¹⁾					
DC voltage 96 V					= G96					
For further ordering codes for other voltages, see page 6										

AC voltage mains (permissible voltage tolerance ± 10%)	Nominal voltage of the DC voltage solenoid in case of operation with AC voltage	Ordering code
110 V - 50/60 Hz	96 V	G96
120 V - 60 Hz	110 V	G110
230 V - 50/60 Hz	205 V	G205

	K4	/			*		
							Further details in the plain text
						No code =	without locating hole
						/62 =	with locating hole and locating pin ISO 8752-3x8-St
						No code =	NBR seals
						V =	FKM seals
							(other seals upon request)
							Attention!
							Observe compatibility of seals with hydraulic fluid used!
						No code =	without check valve insert, without throttle insert
						P =	with check valve insert
						B12 =	Throttle Ø 1.2 mm [0.047 inch]
						B15 =	Throttle Ø 1.5 mm [0.059 inch]
						B18 =	Throttle Ø 1.8 mm [0.071 inch]
						B20 =	Throttle Ø 2.0 mm [0.079 inch]
						B22 =	Throttle Ø 2.2 mm [0.087 inch]
							Other orifices upon request
						No code =	Spool position monitoring
						Q MAG24 =	without position switch
						Q MBG24 =	Monitored spool position "a"
							Monitored spool position "b"
							For further details see RE 24830
						K4²⁾ =	Electrical connection
							without mating connector, individual connection with connector according to DIN EN 175301-803
						N9 =	with concealed manual override
						No code =	without manual override

¹⁾ For connection to the AC voltage mains, a DC voltage solenoid **must** be used, which is controlled via a rectifier (see table page 2).

A mating connector with integrated rectifier can be used (separate order, see page 13).

²⁾ Mating connectors, separate order, see page 13.

Standard types and units are contained in the EPS (standard price list).

Function, section, symbols: 2/2 and 3/2 directional seat valve

General

The directional valve type M-.SED is a direct operated directional seat valve with solenoid actuation. It controls start, stop and direction of the flow and basically comprises a housing (1), solenoid (2), valve seats (7) and (11) and closing element (4).

The manual override (6) allows for the operation of the valve without solenoid energization.

Basic principle (3/2 directional seat valve)

The initial position of the valve (normally open "UK" or normally closed "CK") is determined by the arrangement of the spring (5). The chamber (3) behind the closing element (4) is connected to port P and sealed against port T. Thus, the valve is pressure-compensated in relation to the actuating forces (solenoid and spring).

Due to the special closing element (4), ports P, A, and T can be loaded with the maximum operating pressure (350 bar) and the flow can be directed into both directions (see symbols)!

In the initial position, the closing element (4) is pressed onto the seat (11) by the spring (5), in operated position onto the seat (7) by the solenoid (2). The flow is blocked.

With the 2/2 directional seat valve, the tank port is blocked internally.

2/2 directional seat valve	3/2 directional seat valve
<p>"PK"</p>	<p>"UK"</p>
<p>"NK"</p>	<p>"CK"</p>

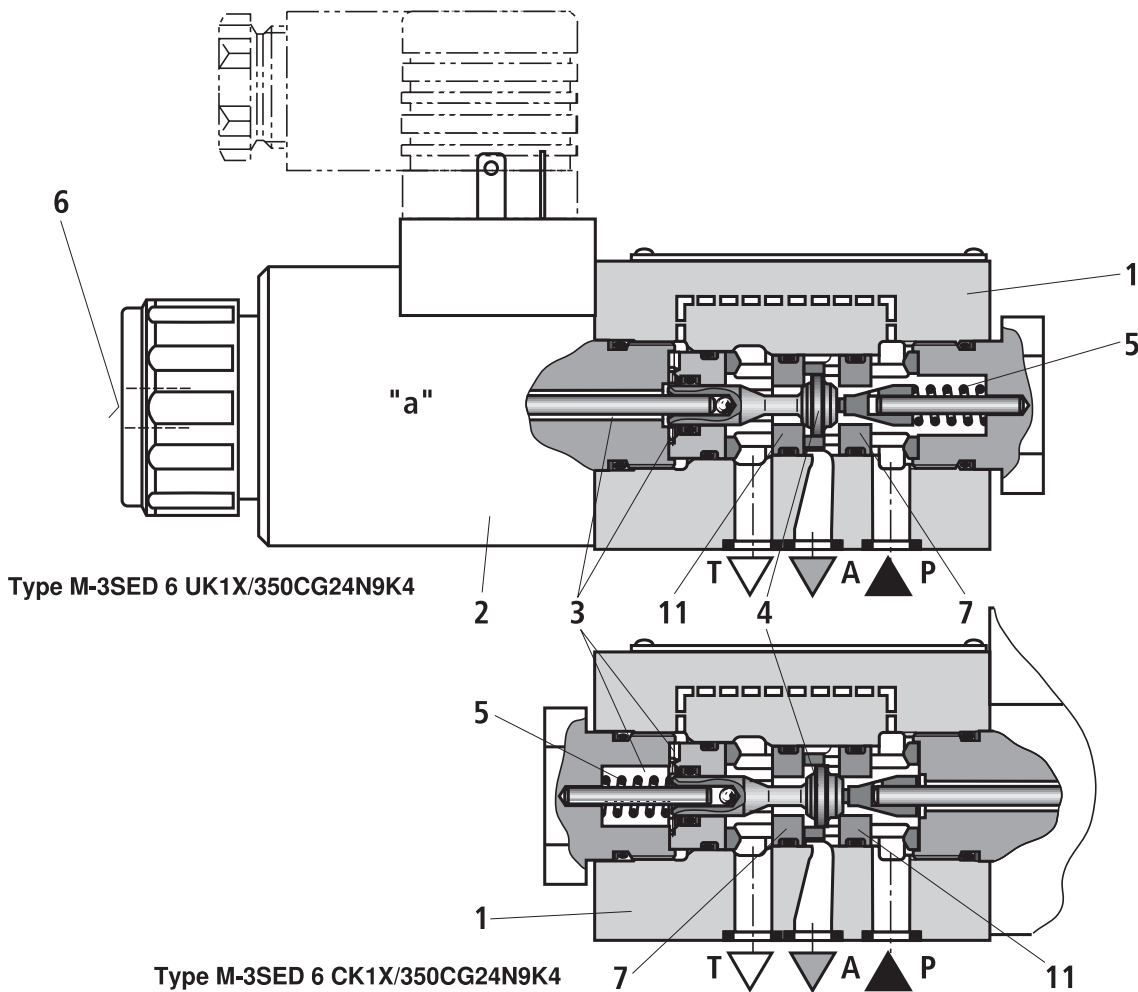

Function, section, symbols, schematic illustration: 4/2 directional seat valve

With a sandwich plate, the **Plus-1 plate** under the 3/2 directional seat valve, the function of a 4/2 directional seat valve is achieved.

Function of the Plus-1 plate

– Initial position:

The main valve is not operated. The spring (5) holds the closing element (4) on the seat (11). Port P is blocked and A connected to T. One pilot line is connected from A to the large area of the pilot spool (8), which is thus unloaded to the tank. The pressure applied via P now pushes the ball (9) onto the seat (10). Thus, P is connected to B, and A to T.

– Transition position:

When the main valve is operated, the closing element (4) is shifted against the spring (5) and pressed onto the seat (7). During this, port T is closed, P, A, and B are briefly connected to each other.

– Spool position:

P is connected to A. Because the pump pressure acts via A on the large area of the pilot spool (8), the ball (9) is pressed onto the seat (12). Thus, B is connected to T, and P to A. The ball (9) in the Plus-1 plate has a “positive spool overlap”.

Attention!

To prevent pressure intensification in conjunction with single-rod cylinders, the annulus area of the cylinder must be connected to A.

The use of the Plus-1 plate and the seat arrangement offer the following options:

Symbol “D”:

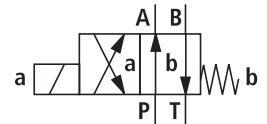

Symbol “Y”:

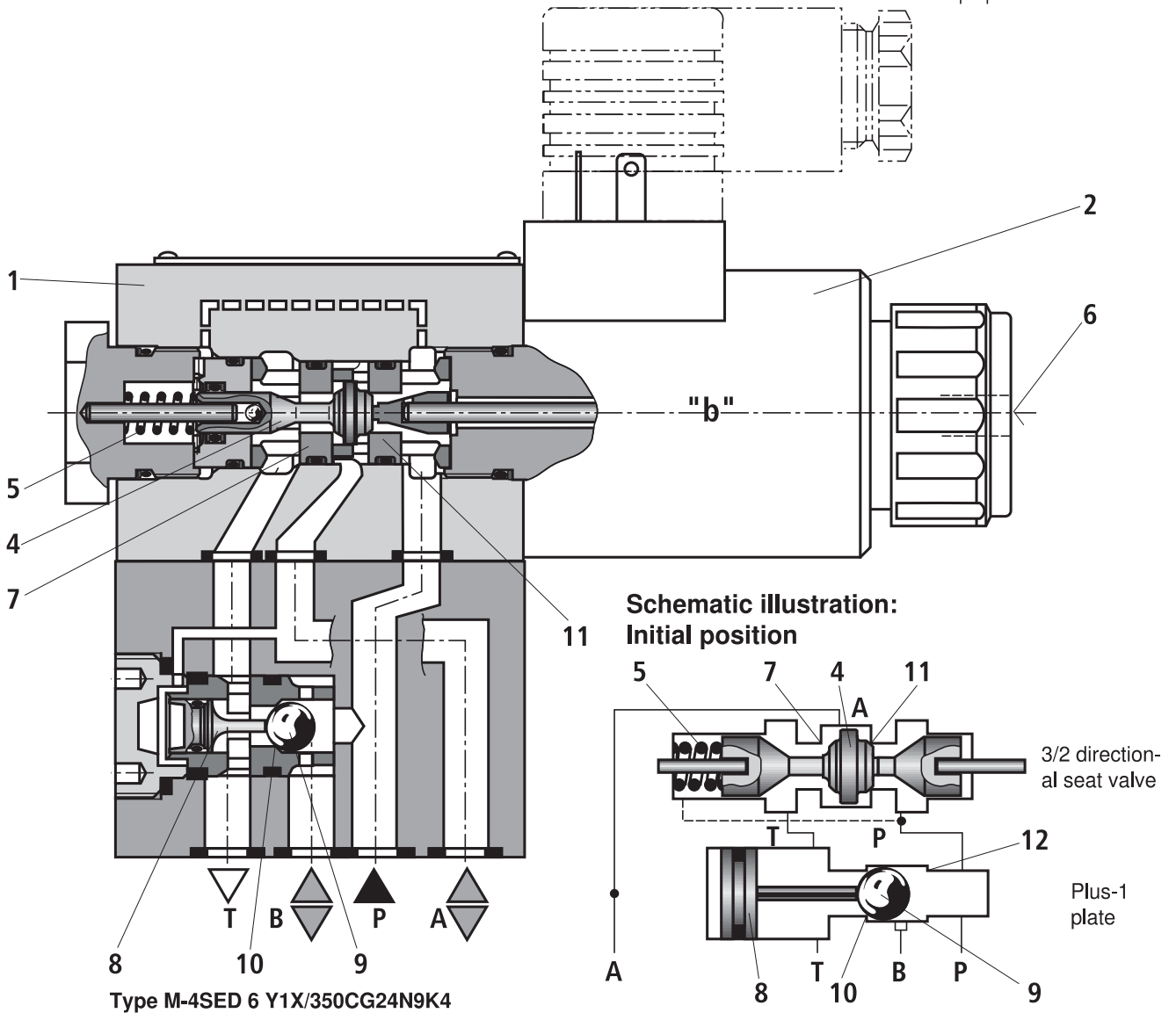
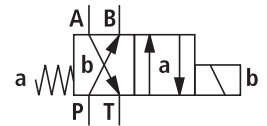

Technical data (For applications outside these parameters, please consult us!)**general**

Weight	– 2/2 directional seat valve	kg [lbs]	1.5 [3.3]
	– 3/2 directional seat valve	kg [lbs]	1.5 [3.3]
	– 4/2 directional seat valve	kg [lbs]	2.3 [5.1]
Installation position			Any
Ambient temperature range		°C [°F]	–30 to +50 [–22 to +122] (NBR seals) –20 to +50 [–4 to +122] (FKM seals)

hydraulic

Maximum operating pressure	bar [psi]	See performance limit page 8
Maximum flow	l/min [gpm]	25 [6.6]
Hydraulic fluid		Mineral oil (HL, HLP) according to DIN 51524 ¹⁾ ; fast biodegradable hydraulic fluids according to VDMA 24568 (see also RE 90221); HETG (rape seed oil) ¹⁾ ; HEPG (polyglycols) ²⁾ ; HEES (synthetic esters) ²⁾ ; other hydraulic fluids upon request
Hydraulic fluid temperature range	°C [°F]	–30 to +80 [–22 to +176] (NBR seals) –20 to +80 [–4 to +176] (FKM seals)
Viscosity range	mm ² /s [SUS]	2.8 to 500 [35 to 2320]
Maximum permitted degree of contamination of the hydraulic fluid - cleanliness class according to ISO 4406 (c)		Class 20/18/15 ³⁾

electrical

Type of voltage		Direct voltage	Alternate voltage
Available voltages ⁴⁾	V	12, 24 , 42, 96, 110, 205, 220	Only possible via rectifier (see page 13)
Voltage tolerance (nominal voltage)	%	±10	
Power consumption	W	30	
Duty cycle	%	100	
Switching time according to ISO 6403	– ON	ms	40 to 70
	– OFF	ms	10 to 20 (without rectifier) 30 to 45 (with rectifier)
Maximum switching frequency	– Operating pressure ≤ 350 bar	1/h	15000
	– Operating pressure > 350 bar	1/h	3600
Type of protection according to DIN EN 60529		IP 65 with mating connector mounted and locked	
Maximum surface temperature of the spool ⁵⁾		°C [°F]	120 [248]

¹⁾ Suitable for NBR and FKM seals

²⁾ Only suitable for FKM seals

³⁾ The cleanliness classes specified for the components must be adhered to in hydraulic systems. Effective filtration prevents malfunction and at the same time increases the service life of the components.

For selecting the filters, see data sheets RE 50070, RE 50076, RE 50081, RE 50086, RE 50087 and RE 50088.

⁴⁾ Special voltages upon request

⁵⁾ Due to the temperatures occurring at the surfaces of the solenoid coils, the standards ISO 13732-1 and EN 982 need to be adhered to!

When establishing the electrical connection, the protective earth conductor (PE $\frac{1}{2}$) has to be connected properly.

Characteristic curves (measured with HLP46, $\vartheta_{oil} = 40 \pm 5 \text{ }^\circ\text{C}$ [$104 \pm 9 \text{ }^\circ\text{F}$])

Δp - q_v characteristic curves
2/2 and 3/2 directional seat valve

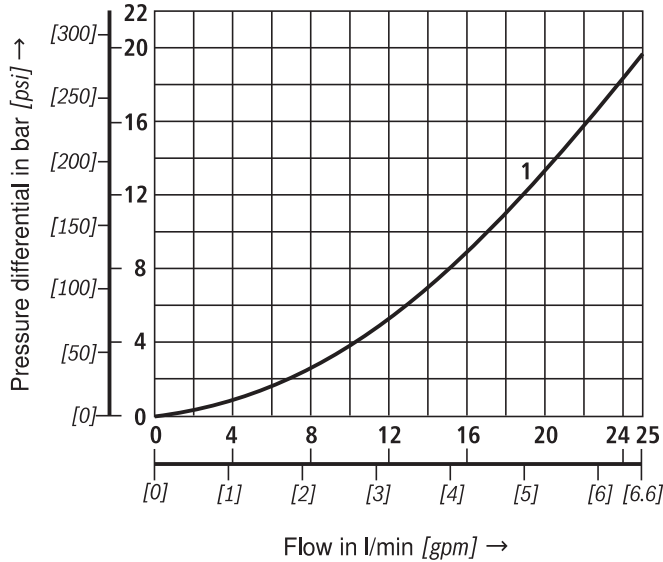

- 1 M-2SED 6 **PK** ..., P to A
NK
- 1 M-3SED 6 **UK** ..., P to A and A to T
CK

Δp - q_v characteristic curves
4/2 directional seat valve

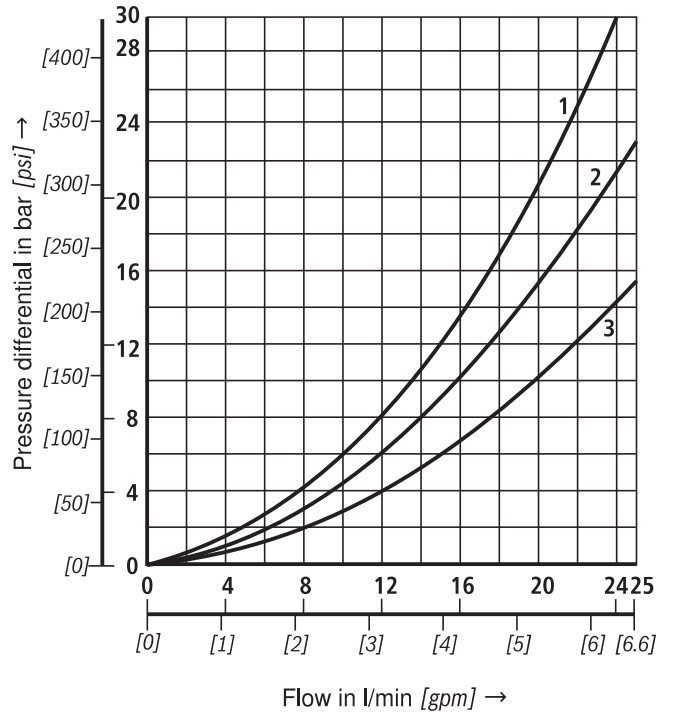

- 1 M-4SED 6 **D** ..., A to T
Y
- 2 M-4SED 6 **D** ..., P to A
Y
- 3 M-4SED 6 **D** ..., B to T and P to B
Y

Δp - q_v characteristic curves
Check valve insert

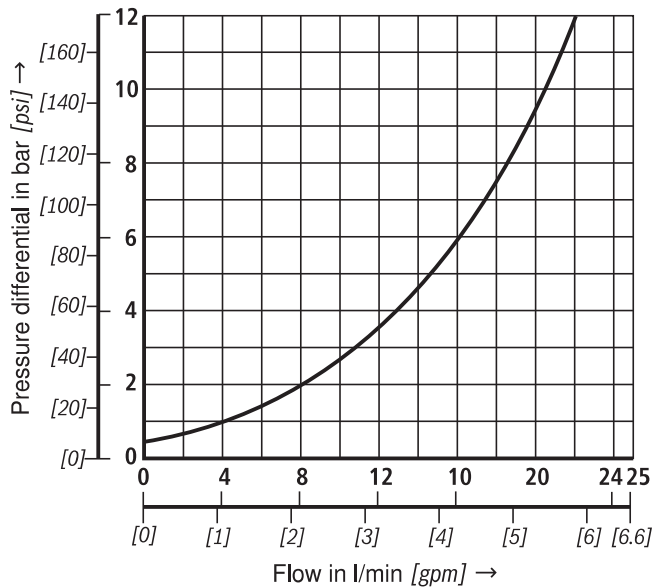

Δp - q_v characteristic curves
Throttle insert

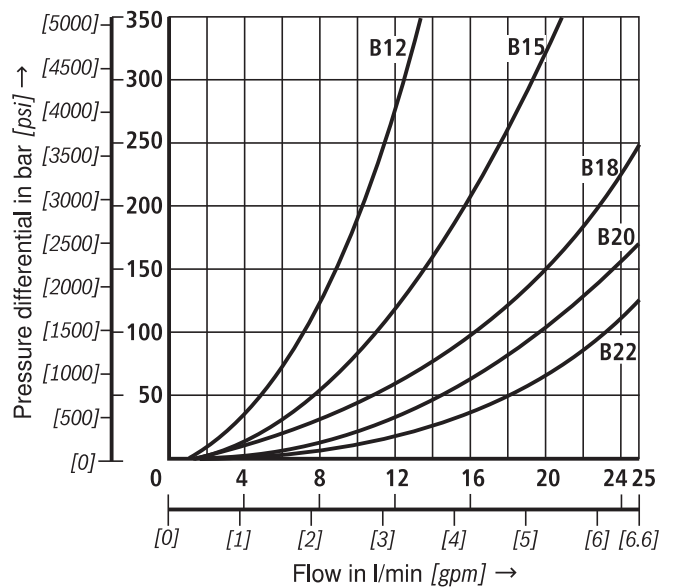

Performance limit (measured with HLP46, $\vartheta_{oil} = 40 \pm 5 \text{ }^\circ\text{C}$ [$104 \pm 9 \text{ }^\circ\text{F}$])

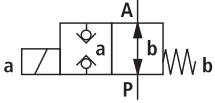
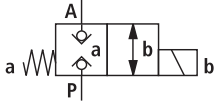
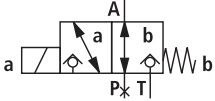
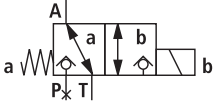
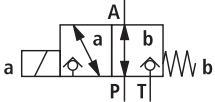
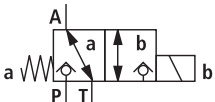
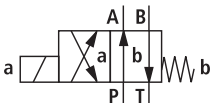
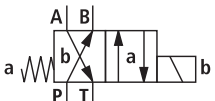
	Symbol	Comment	Operating pressure in bar [psi]				Flow in l/min [gpm]
			P	A	B	T	
2-way circuit (2/2 directional seat valve)	PK 		350 [5100]	350 [5100]			25 [6.6]
	NK 		350 [5100]	350 [5100]			25 [6.6]
2-way circuit (3/2 directional seat valve)	UK 	With 2/2 directional circuit, port P or T has to be closed on the customer side!	350 [5100]	350 [5100]		350 [5100]	25 [6.6]
	CK 		350 [5100]	350 [5100]		350 [5100]	25 [6.6]
3-way circuit	UK 		350 [5100]	350 [5100]		350 [5100]	25 [6.6]
	CK 		350 [5100]	350 [5100]		350 [5100]	25 [6.6]
4-way circuit (flow only possible in the direction of the arrow!)	D 	3/2 directional valve (symbol "UK") in connection with Plus-1 plate: $p_P > p_A \geq p_B > p_T$	350 [5100]	350 [5100]	350 [5100]	$p_P - 40$ [580]	25 [6.6]
	Y 	3/2 directional valve (symbol "CK") in connection with Plus-1 plate: $p_P > p_A \geq p_B > p_T$	350 [5100]	350 [5100]	350 [5100]	$p_P - 40$ [580]	25 [6.6]

Attention!

The performance limits were determined when the solenoids were at operating temperature, at 10% undervoltage and without tank pre-loading.

Unit dimensions: 2/2 directional seat valve (“PK”) and 3/2 way seat valve (“UK”)
(dimensions in mm [inch])

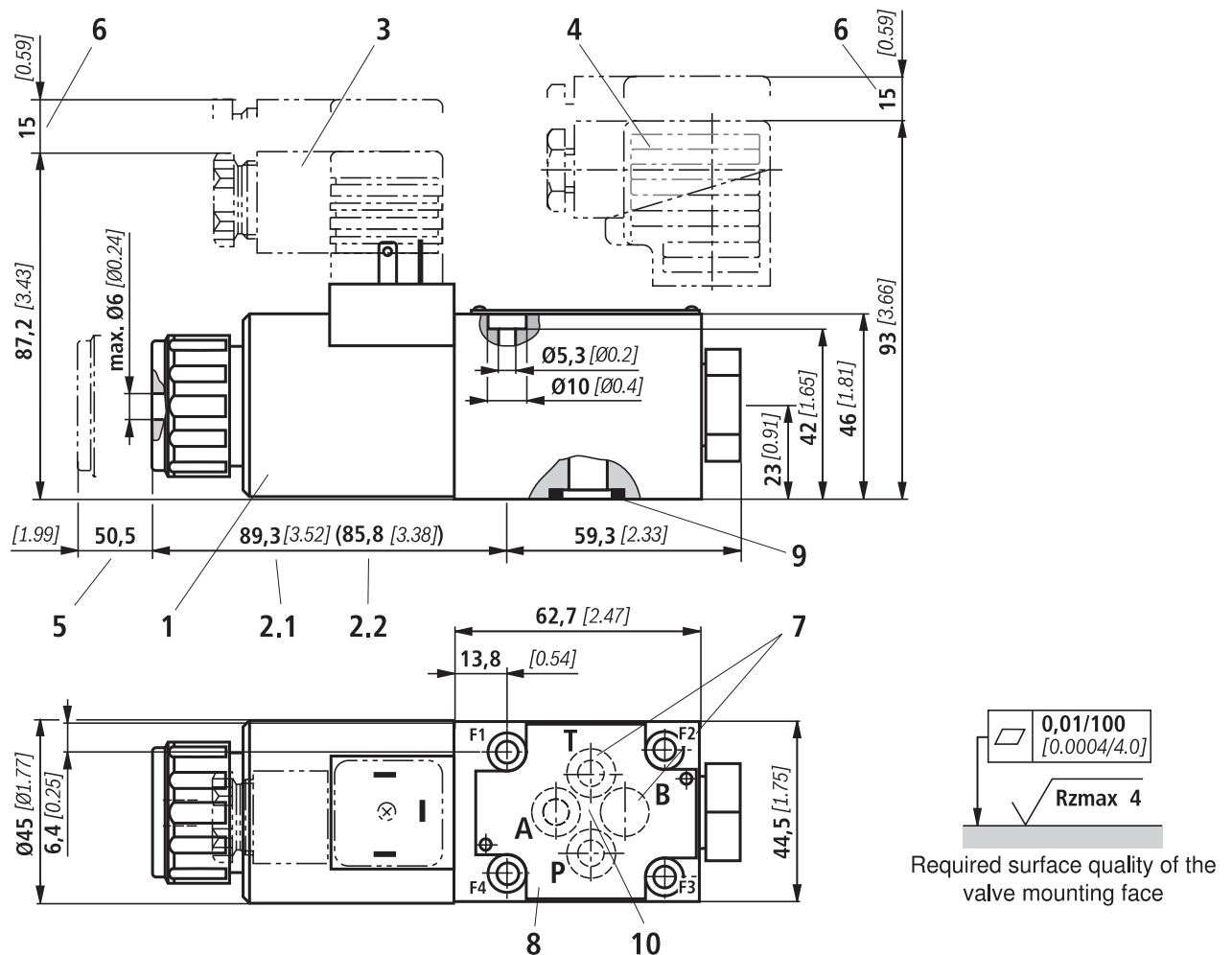

- 1 Solenoid “a”
- 2.1 Dimension of valve with concealed manual override “N9”
- 2.2 Dimension of valve without manual override
- 3 Mating connector **without** circuitry (separate order, see page 13)
- 4 Mating connector **with** circuitry (separate order, see page 13)
- 5 Space required for removing the coil
- 6 Space required for removing the mating connector
- 7 **Attention!**
Port B is provided as blind counterbore on 2/2 and 3/2 directional seat valves. With 2/2 directional seat valves, port T is blocked internally.
- 8 Nameplate
- 9 Identical seal rings for ports A, B and T; seal ring for port P
- 10 Porting pattern according to DIN 24340 form A (**without** locating hole), or ISO 4401-03-02-0-05 and NFPA T3.5.1 R2-2002 D03 (**with** locating hole for locating pin ISO 8752-3x8-St, material no. **R900005694**, included in scope of delivery)

Subplates see RE 45052.

Valve mounting screws see page 13.

Unit dimensions: 2/2 directional seat valve ("NK") and 3/2 directional seat valve ("CK")
(dimensions in mm [inch])

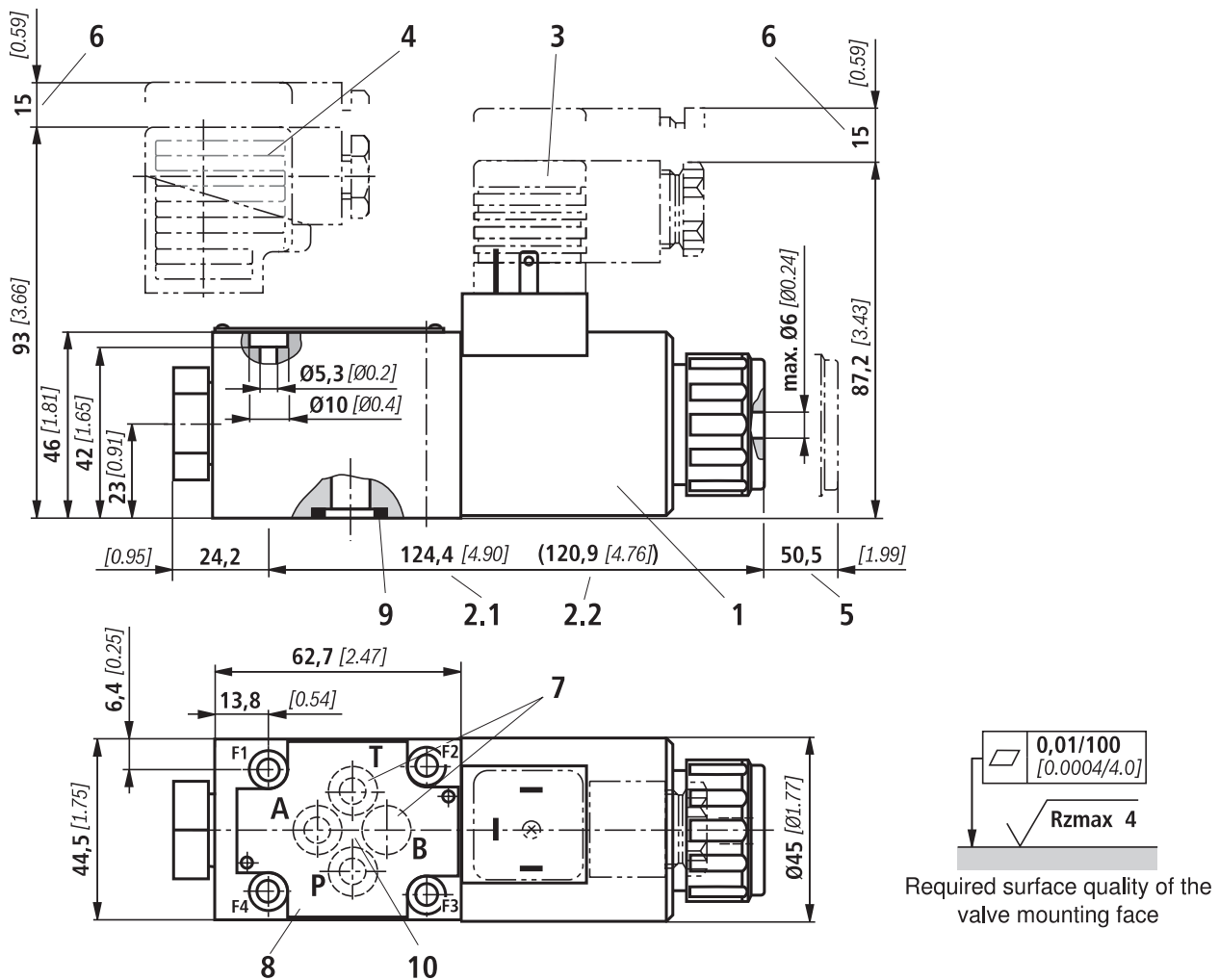

- 1 Solenoid "b"
- 2.1 Dimension for valve with concealed manual override "N9"
- 2.2 Dimension of valve without manual override
- 3 Mating connector **without** circuitry (separate order, see page 13)
- 4 Mating connector **with** circuitry (separate order, see page 13)
- 5 Space required for removing the coil
- 6 Space required for removing the mating connector
- 7 **Attention!**
Port B is provided as blind counterbore on 2/2 and 3/2 directional seat valves. With 2/2 directional seat valves, port T is blocked internally.
- 8 Nameplate
- 9 Identical seal rings for ports A, B and T; seal ring for port P
- 10 Porting pattern according to DIN 24340 form A (**without** locating hole), or ISO 4401-03-02-0-05 and NFPA T3.5.1 R2-2002 D03 (**with** locating hole for locating pin ISO 8752-3x8-St, material no. **R900005694**, included in scope of delivery)

Subplates see RE 45052.

Valve mounting screws see page 13.

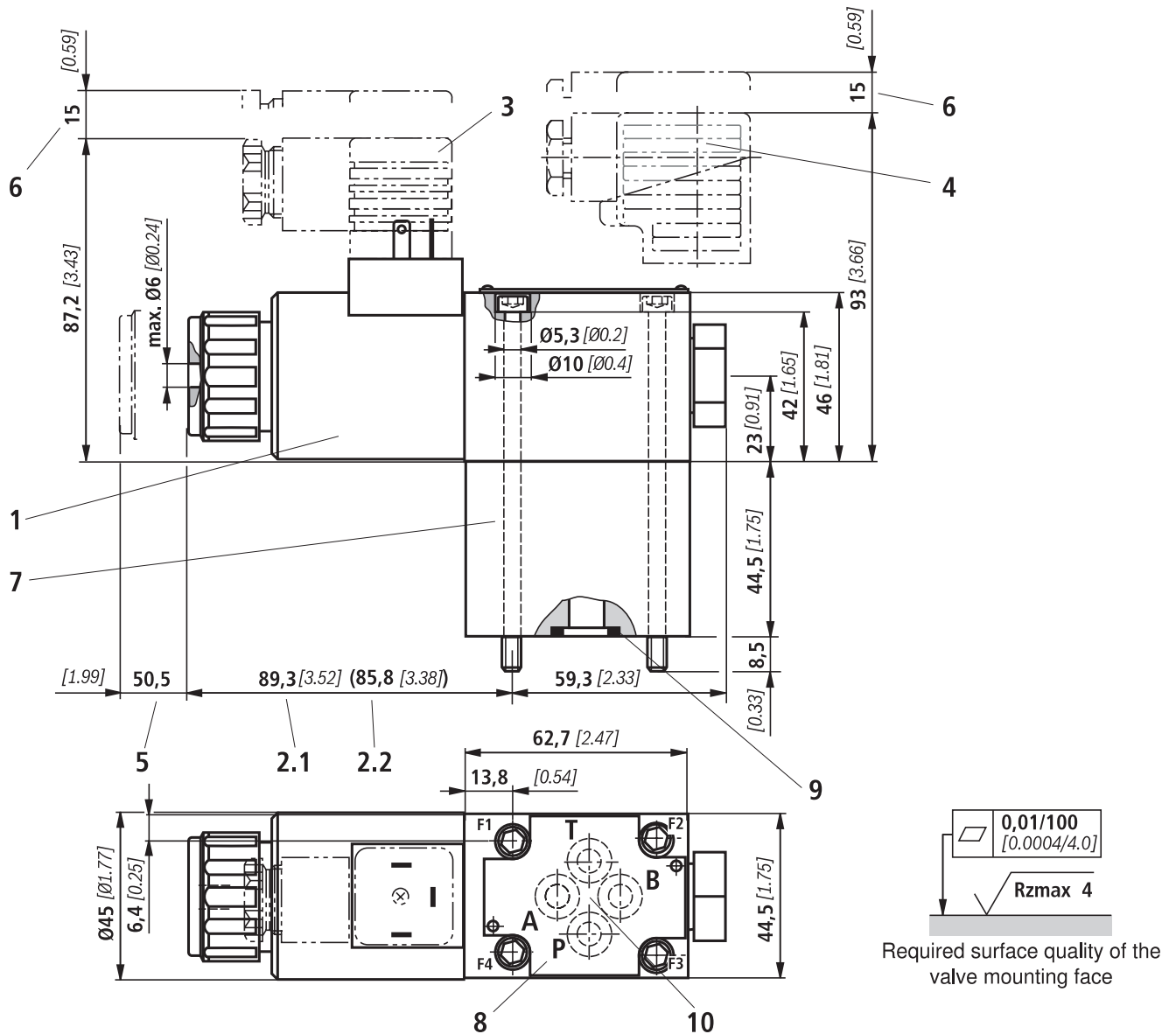
Unit dimensions: 4/2 directional seat valve ("D") (dimensions in mm [inch])

- | | |
|--|---|
| <p>1 Solenoid "a"</p> <p>2.1 Dimension for valve with concealed manual override "N9"</p> <p>2.2 Dimension for valve without manual override</p> <p>3 Mating connector without circuitry (separate order, see page 13)</p> <p>4 Mating connector with circuitry (separate order, see page 13)</p> <p>5 Space required for removing the coil</p> <p>6 Space required for removing the mating connector</p> <p>7 Plus-1 plate</p> <p>8 Nameplate</p> <p>9 Identical seal rings for ports A, B and T; seal ring for port P</p> | <p>10 Porting pattern according to DIN 24340 form A (without locating hole), or ISO 4401-03-02-0-05 and NFPA T3.5.1 R2-2002 D03 (with locating hole for locating pin ISO 8752-3x8-St, material no. R900005694, included in scope of delivery)</p> <p>Subplates see RE 45052.</p> <p>Valve mounting screws see page 13.</p> |
|--|---|

Unit dimensions: 4/2 directional seat valve (“Y”) (dimensions in mm [*inch*])

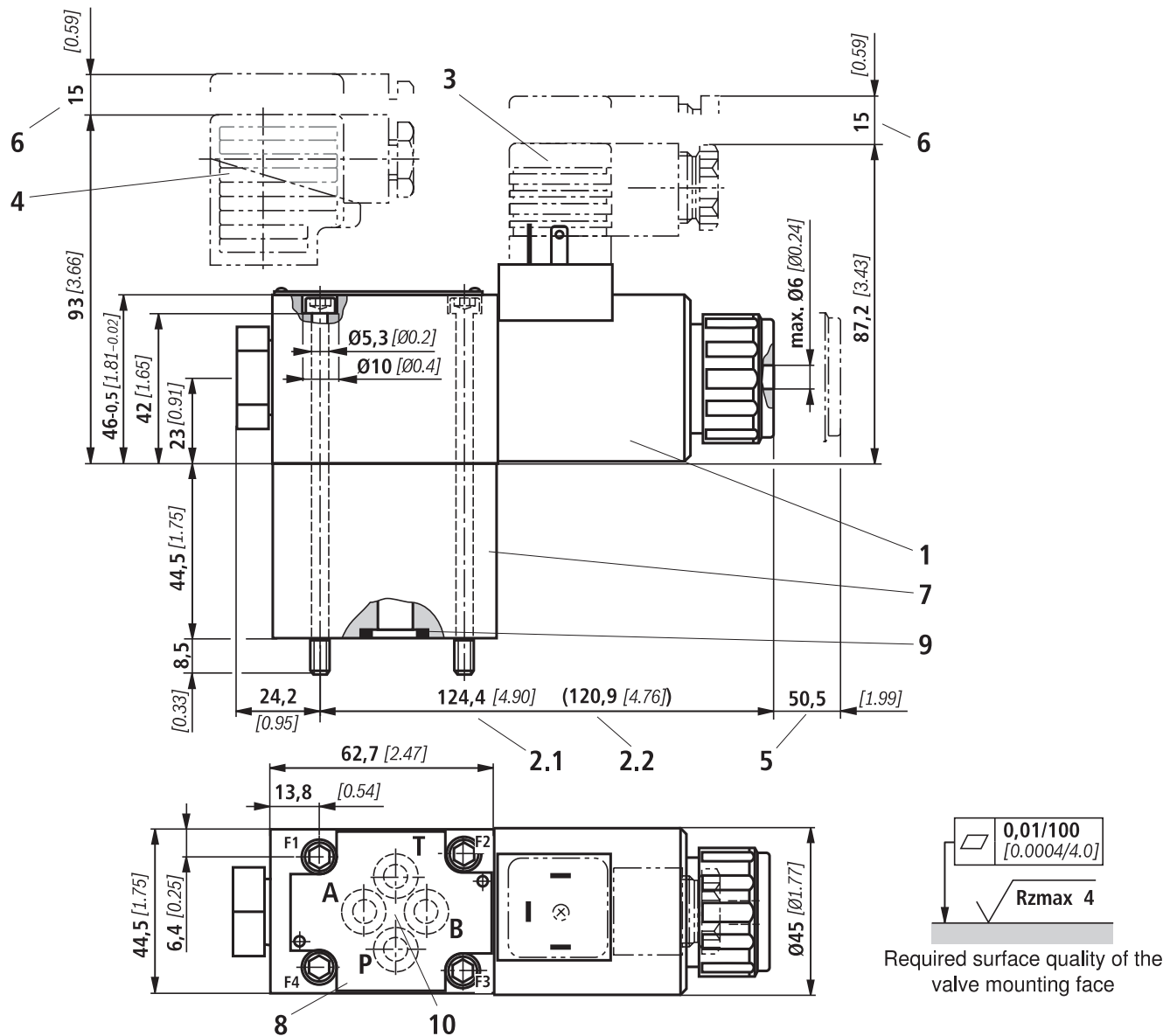

- 1 Solenoid “b”
- 2.1 Dimension for valve with concealed manual override “N9”
- 2.2 Dimension for valve without manual override
- 3 Mating connector **without** circuitry (separate order, see page 13)
- 4 Mating connector **with** circuitry (separate order, see page 13)
- 5 Space required for removing the coil
- 6 Space required for removing the mating connector
- 7 Plus-1 plate
- 8 Nameplate
- 9 Identical seal rings for ports A, B and T; Seal ring for port P
- 10 Porting pattern according to DIN 24340 form A (**without** locating hole), or ISO 4401-03-02-0-05 and NFPA T3.5.1 R2-2002 D03 (**with** locating hole for locating pin ISO 8752-3x8-St, Material no. **R900005694**, included in scope of delivery)

Subplates see RE 45052.

Valve mounting screws see page 13.

Valve mounting screws

2/2 and 3/2 directional seat valve

4 hexagon socket head cap screws metric
ISO 4762 - M5 x 50 - 10.9-f1Zn-240h-L (separate order)
(friction coefficient $\mu_{\text{total}} = 0.09$ to 0.14);
Tightening torque $M_A = 7 \text{ Nm}$ [5.2 ft-lbs] $\pm 10 \%$,
Material no. **R913000064**

or

4 hexagon socket head cap screws
ISO 4762 - M5 x 50 - 10.9 (self procurement)
(friction coefficient $\mu_{\text{total}} = 0.12$ to 0.17);
Tightening torque $M_A = 8.1 \text{ Nm}$ [6 ft-lbs] $\pm 10 \%$

4 hexagon socket head cap screws UNC
10-24 UNC x 2" (self procurement)
(friction coefficient $\mu_{\text{total}} = 0.19$ to 0.24 according to ASTM-574);
Tightening torque $M_A = 11 \text{ Nm}$ [8.1 ft-lbs] $\pm 15 \%$,
(friction coefficient $\mu_{\text{total}} = 0.12$ to 0.17 according to ISO 4762);
Tightening torque $M_A = 8 \text{ Nm}$ [5.9 ft-lbs] $\pm 10 \%$,
Material no. **R978833365**

4/2 directional seat valve

4 hexagon socket head cap screws metric
ISO 4762 - M5 x 95 - 10.9-f1Zn-240h-L (included in scope of delivery)

(friction coefficient $\mu_{\text{total}} = 0.09$ to 0.14);
Tightening torque $M_A = 7 \text{ Nm}$ [5.2 ft-lbs] $\pm 10 \%$,

Material no. **R913000223**

or

4 hexagon socket head cap screws
ISO 4762 - M5 x 95 - 10.9 (self procurement)
(friction coefficient $\mu_{\text{total}} = 0.12$ to 0.17);
Tightening torque $M_A = 8.1 \text{ Nm}$ [6 ft-lbs] $\pm 10 \%$

4 hexagon socket head cap screws UNC
10-24 UNC x 3 3/4" (self procurement)
(friction coefficient $\mu_{\text{total}} = 0.19$ to 0.24 according to ASTM-574);
Tightening torque $M_A = 11 \text{ Nm}$ [8.1 ft-lbs] $\pm 15 \%$,
(friction coefficient $\mu_{\text{total}} = 0.12$ to 0.17 according to ISO 4762);
Tightening torque $M_A = 8 \text{ Nm}$ [5.9 ft-lbs] $\pm 10 \%$,
Material no. **R978881682**

Mating connectors according to DIN EN 175301-803

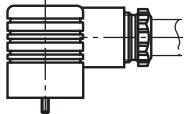
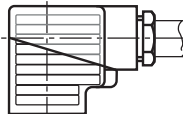
Details and more mating connectors see RE 08006						
Connection	Valve side	Color	Material no.			
			without circuitry	with indicator light 12 ... 240 V	with rectifier 12 ... 240 V	with indicator light and Zener diode suppression circuit 24 V
M16 x 1.5	a	Gray	R901017010	–	–	–
	b	Black	R901017011	–	–	–
	a/b	Black	–	R901017022	R901017025	R901017026
1/2" NPT (Pg16)	a	Red/brown	R900004823	–	–	–
	b	Black	R900011039	–	–	–
	a/b	Black	–	R900057453	R900842566	–

Throttle insert

The use of a throttle insert is required when due to prevailing operating conditions, flows can occur during the switching processes, which exceed the performance limit of the valve.

Examples:

- Accumulator operation,
- Use as pilot control valve with internal pilot fluid tapping.

2/2 and 3/2 directional seat valve

The throttle insert is inserted in port P of the seat valve.

4/2 directional seat valve

The throttle insert is inserted in port P of the Plus-1 plate.

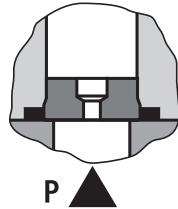

Check valve insert

The check valve insert allows a free flow from P to A and closes A to P leak-free.

2/2 and 3/2 directional seat valve

The check valve insert is inserted in port P of the seat valve.

4/2 directional seat valve

The check valve insert is inserted in port P of the Plus-1 plate.

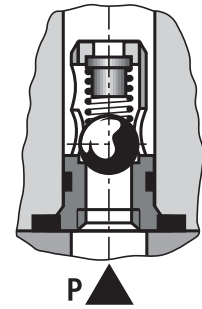

General notes

Seat valves can be used according to the spool symbols as well as the assigned operating pressures and flows (see performance limits page 8).

In order to ensure safe functioning, it is absolutely necessary to observe the following points:

- In order to switch the valve safely or maintain it in its spool position, the pressure situation must be as follows: $p_P \geq p_A \geq p_T$ (for design reasons).
- Seat valves have a negative spool overlap, i.e. during the switching process, leakage oil accrues. This process takes, however, place within such a short time that it is irrelevant in nearly all applications.
- The specified maximum flow must not be exceeded (use a throttle insert for limiting the flow, if necessary)!

Plus-1 plate:

- When the Plus-1 plate (4/2-directional function) is used, the following lower operating values must be taken into account: $p_{min} = 8 \text{ bar}$; $q_V > 3 \text{ l/min}$.
- The ports P, A, B and T are clearly determined according to the tasks. They must not be optionally exchanged or closed.
- With 3- and 4-way spool positions, port T must always be connected.
- Pressure level and pressure distribution must be observed!
- The flow is only permitted in the direction of the arrow!

Notes

Bosch Rexroth AG
Hydraulics
Zum Eisengießer 1
97816 Lohr am Main, Germany
Phone +49 (0) 93 52 / 18-0
Fax +49 (0) 93 52 / 18-23 58
documentation@boschrexroth.de
www.boschrexroth.de

© This document, as well as the data, specifications and other information set forth in it, are the exclusive property of Bosch Rexroth AG. It may not be reproduced or given to third parties without its consent. The data specified above only serve to describe the product. No statements concerning a certain condition or suitability for a certain application can be derived from our information. The information given does not release the user from the obligation of own judgment and verification. It must be remembered that our products are subject to a natural process of wear and aging.