

Installation & Operation Manual

F25 Industrial Radio Remote Controller



Lee's Hi-tech Enterprise. Co., Ltd.

Table Of Contents

Safety Considerations -----	2
-----------------------------	---

Part. 1 Operator's Manual

Chapter 1	Warranty -----	3
Chapter 2	Precautions Of Operation -----	4
Chapter 3	Standard Accessories -----	6
Chapter 4	Operation -----	7
Chapter 5	Inspection and Fault Detection -----	10

Part. 2 Technician's Manual

Chapter 1	General Characteristics -----	11
Chapter 2	System Configuration -----	12
Chapter 3	Installation and Function Setting -----	14
Chapter 4	Software -----	19

Safety Considerations

This product and related documentation must be reviewed for familiarization with safety markings and instructions before operation.

Safety Symbols The following symbols may be found on the remote control or throughout the remote control's documentation.

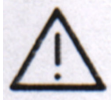

Refer to Manual

When product is marked with this symbol refer to instruction manual for additional information.



High Voltage

Indicates presence of hazardous voltage. Unsafe practice could result in severe personal injury.



Warning

Denotes a hazard. Included text gives proper procedures. Failure to follow instructions could result in severe personal injury and/or property damage.



Caution

Denotes a hazard. Included text gives proper procedures. Failure to follow instructions could result in minor personal injury and/or property damage.

Part 1. Operator's Manual

Chapter 1 Warranty

1-1 *Warranty*

Lee's Hi-Tech Enterprises Co., Ltd. guarantees that this product meets its published specifications at the time of shipment from the factory. Under proper installation it should work as expected.

1-2 *Warranty Period*

This equipment is warranted against defects in material and manufacturing for a period of one year from the date of shipment. During the warranty period, TELECRANE is responsible for necessary repairs as long as the product can be proved to be defective.

For warranty service or repair this product must be returned to a service facility designated by TELECRANE. Buyer will pay shipping charges to TELECRANE while TELECRANE will pay return shipping charges.

1-3 *Excluded Items*

This warranty does not include consumptive parts such as batteries, fuses, buttons, and relays. Also this warranty does not cover defects caused by improper installation, improper or insufficient maintenance, unauthorized modification, improper operation, ignorance of environmental specifications, or improper software or interfacing.

1-4 *Remarks*

- ⊙ No other warranty is expressed or implied, except for the above mentioned.
- ⊙ The remedies provided herein are the buyer's sole and exclusive remedies.
TELECRANE shall not be liable for any direct, indirect, special, incidental or consequential damages.

Chapter 2 Precautions of Operation

2-1 Attention

- ⊙ Please carefully read the manual before installing and operating this device.
- ⊙ Due to the complex nature of this equipment it is necessary to read the entire manual before installation.
-  ⊙ Never dismantle the equipment by any unauthorized personnel, or equipment may be damaged.
- ⊙ This manual is for reference only. Please consult your distributor for further assistance.
- ⊙ The equipment has been strictly tested for quality before delivery from our plant. However, this equipment must not be used in dangerous situations or where damage may result.
- ⊙ After operation, shut off main power to the crane, power to receiver, and remove transmitter key.
- ⊙ Transmitter should be placed in a safe area when not in use to avoid accidental pressing of buttons.
- ⊙ The crane should be equipped with main power relay, limit switch and other safety devices.
- ⊙ Don't use equipment during lightning or high electrical interference conditions.
- ⊙ Make sure that the batteries are in good condition and power for receiver is correct.
- ⊙ Maintenance should only be done while the crane's main power is off to prevent electrical shock.
- ⊙ The contents of this manual may be amended by the manufacturer without notice.
- ⊙ The manufacturer may introduce new functions to the equipment as necessary, therefore, the descriptions may change.

2-2 Precautions

- ☆ Operating in an industrial facility is relatively dangerous; therefore, operator must have taken the adequate trainings in using F25 system.
- ☆ Those who operate the machine should be healthy and have good judgment in regard to safety.
- ☆ Although the F25 transmitter is so durable and resistant for the fluctuating temperature, care still need be taken to prevent it from the severe impact or pressure.
- ☆ During operation, if the power supply of the transmitter's batteries is insufficient, the transmitter will send out EMS signal first to de-energize all of motion relays inside the receiver to stop crane's moving, and then the LED indicator on transmitter will flash in red constantly. At this moment, the batteries need to be replaced and all of four batteries should be replaced at the same time.
- ☆ If the severe interference occurred the equipment should be stopped at once.
- ☆ Please take the batteries out when the equipment will not be used for a long time.
- ☆ Be sure to know the "Procedures of Emergency" as follows.

2-3 Procedures of emergency

In case of an Emergency, please follow the steps below and ask the distributor for service immediately.

1. Press "EMS" button.
2. Turn the key to "OFF" position and remove it.
3. Switch off the main power of crane.
4. Advise the distributor to find out the reason.

Chapter 3 F25 Standard Accessories

When you acquire a standard and full set of F25 system, it includes the following items.



(1) Transmitter, one unit.



(2) Receiver, one unit.

Chapter 4 Operation

4-1 F25 Transmitter's parts

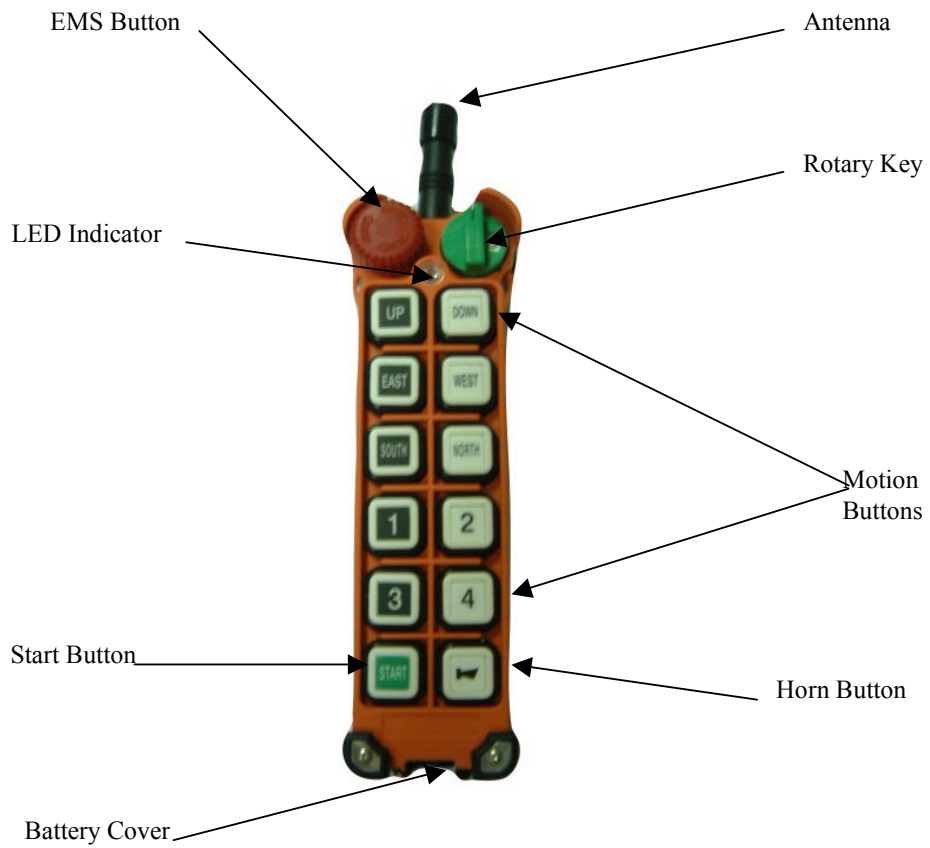

4-2 F25 Receiver's parts



4-3 General Operation



1. Install four AA size batteries in the transmitter and make sure the "+" and "-" direction are correct.
2. Insert the rotary key into the keyhole at "OFF" position and then turn clockwise to "ON" position.
3. Press the "Start" pushbutton to Power-On.

Note:

If fail to follow the procedure above, the LED light will indicate fast flashing in red.

4. Operate normally according to the function setting has done.
5. Please proceed the following procedure after operation.
 - a) Press EMS mushroom
 - b) Turn the rotary key to "OFF" position.
 - c) Remove the rotary key.
 - d) Remove the batteries when the equipment is not going to be used for a long period of time

Note:

1. There is a 3-stage power indicating function with LED display.
 - (1) "Green color": Sufficient power to operate transmitter.
 -  (2) "Yellow color": Power is depleting. Operation must be stopped immediately (for example: down the loads to ground) to replace batteries.
 -  (3) "Red color": Insufficient power. Transmitter will send out an emergency stop signal to the receiver due to insufficient power. Operator should avoid this situation in order to maintain the safety of operation.
2. Turn the rotary key of the transmitter to "OFF" position; it will not only shut off the motion of the receiver but also save the power. Otherwise, the transmitter will keep staying in the standby mode and causing more power consumption.

Chapter 5. Inspection and Fault Detection

5-1 Inspection

Daily inspection is important and will ensure the safety of operation. Inspection should include "emergency stop" and other safety devices and functions. If there is any doubt, operation must be stopped immediately and problems must be solved before resume of operation.

5-2 Fault Detection

F25 is equipped with simple fault detection mechanism. While start and during the operation, fault detection mechanism will indicate the faulty signals if any malfunction is detected. Operator must understand the faulty signals and notify the maintenance personnel.

5-2-1 Transmitter Fault Detection

If the LED light on the transmitter is fast flashing in red, then there must be the causes as follows:

1. Some of the push buttons are jammed or stock.
2. EMS button has not been released.
3. Fail to follow the correct Power-On procedure.

5-2-2 Receiver Fault Detection

Malfunction Types and LED indicators of the receiver are listed as follows:

G1	R1	G2	R2	Malfunction Type
		On	On	MCU1 or MCU2 Fault
Blink Simultaneously with R1	Blink Simultaneously with G1			Main (EMS) Relays Fault
Blink Alternately with R1	Blink Alternately with G1			Relay Driver Buffer Fault
	Blink			Some of the Motion Relays are Jammed
			On	Receiver fails to receive the correct signal and the Passive EMS action activated.

Part 2. Technician's Manual

Chapter 1 General Characteristic

1-1 General Specifications

- Operation Frequency----- : 433.05~434.79MHz
- Hamming Distance ----- : ≥ 4
- I.D. Code----- : 2²⁰ sets (set by factory, never repeated)
- Temperature Range----- : -40°C ~ +85°C
- Channel Spacing----- : 25 KHz
- Maximum Operation Range----- : Up to 100 Meters
- Structure----- : Reinforced Plastic and Glass Fiber
- Protection Degree----- : IP 65

1-2 Transmitter Specifications

- Power Supply----- : Four 1.5 volts Batteries (AA Size)
- RF Power----- : < 10 mW
- Pushbutton Type----- : Two step mechanical switch
- Dimensions----- : 186x61x51mm (LxWxH)
- Weight----- : about 265g (including batteries)

1-3 Receiver Specifications

- Power Supply----- : 48/110/ 220/380VAC (50/60Hz), $\pm 20\%$
- Sensitivity----- : -110dBm
- Output Relays----- : 5A/250VAC
- Dimensions----- : 200x162x107mm (LxWxH)
- Weight----- : about 1220g(excluding wire cable)

Chapter 2. System Configuration

2-1 Transmitter Unit

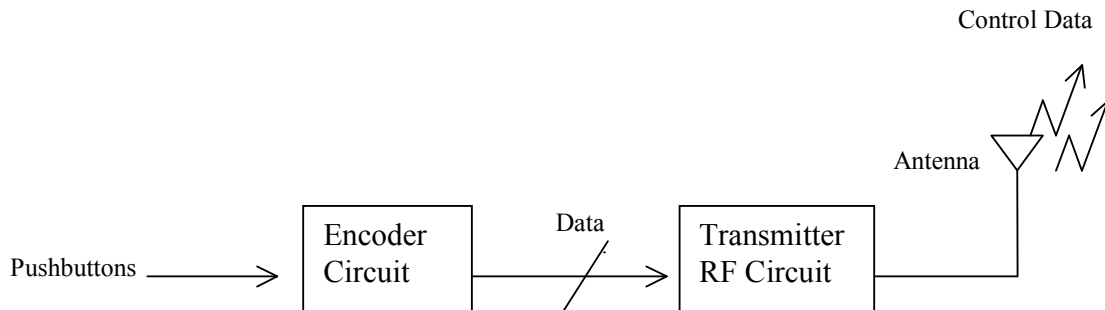

Figure A. Transmitter block diagram

The transmitter unit consists of an Encoder Circuit and a Transmitter RF Circuit. When the user presses a pushbutton on the transmitter, the Encoder Circuit senses the pushbutton's data immediately. The Encoder Circuit then encodes the pushbutton's data, combined with the ID Code and a Hamming Code to become the "control data".

This control data goes to the transmitter RF circuit to modulate a radio frequency (RF) carrier. The output FM signal from the modulator is then sent to the antenna to generate the transmission signal via an RF amplifier and a low-pass filter.

2-2 Receiver Unit

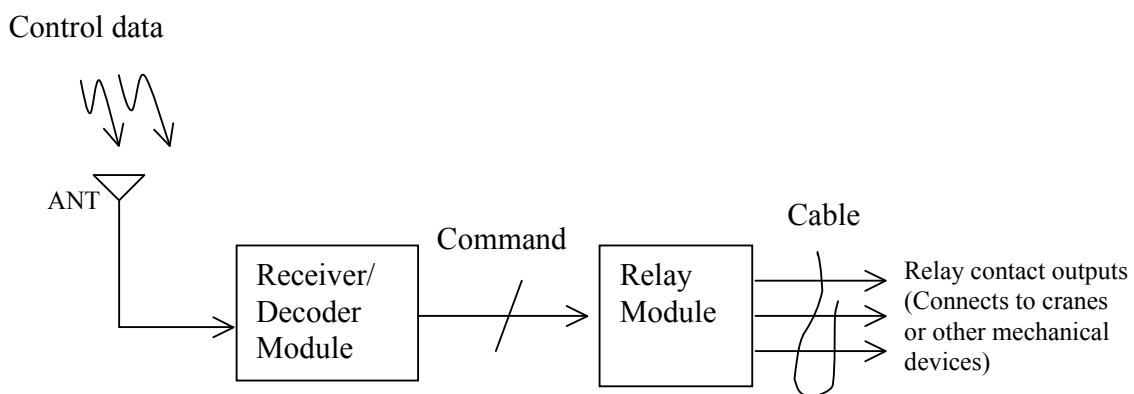

Figure B. Receiver block diagram

The receiver unit consists of the Receiver/Decoder module and the Relay module. RF signals (control data) from the transmitter are received by the antennas and sent

to the Receiver/ Decoder module. The main functions of the Receiver/Decoder module are to process the RF signal from the transmitter through the signal processing circuits, consisting of the band-pass filter, RF amplifier, mixer, IF amplifier, demodulator, error detection, error correction circuits, and decoder in order to generate a control command sent to the Relay module to drive the corresponding relay.

The Relay element is the interface of the Remote Controller to a crane or other mechanical device. The wiring between the relay contact outputs and the control circuit (or control box) of the crane or mechanical device can be arranged by the user.

2-3 Error detection/Error correction by software

F25 system employs the theory of "Error-Control Coding" used on Computer system, and incorporates the "Control Data Code" and the principle of "Error detection/Error correction" of Hamming Distance to edit and complete the "Code Word" was so-called "Hamming Code" which may ensure the control data with accuracy in process of transmission, and also equip with function of automatic "Error detection/Error correction" to make sure the safety in operation of F25 system remote control.

2-3-1 Data Stream

As shown as below, before the receiver's relays output to control the equipment's movement, the data including SYNC, ID-CODE, COMMAND and SUM must be checked twice to further make sure, so the data transmission becomes more safe and reliable.

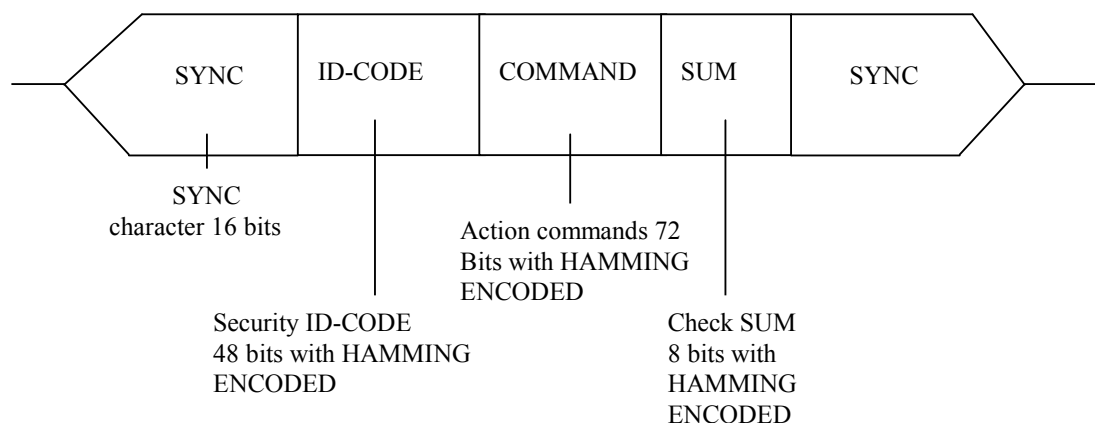

TOTAL DATA LENGTH= 144 bits

2-3-2 Hamming Code

It is shown as below, the Code Word length is equal to 8, the Data Bit is equal to 4, the Hamming Distance is equal to 4, it means that HAMMING CODE (8,4,4) can correct single-bit errors and also detect double-bit errors.

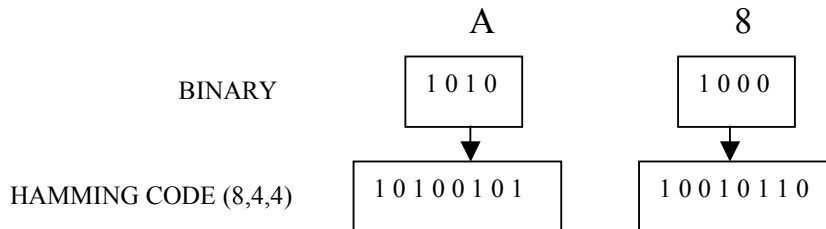

Chapter 3. Installation And Function Setting

3-1 Precautions during installation

1. Observe all safety precautions when climbing the crane.
- ⚡ 2. Turn off the main power source of cranes before installation to avoid electric shock.
3. Receiver must be installed in the way that it will not touch any part of the building during the operation.
4. Receiver must be fastened safely.
5. Before installation, inspect the crane's safety devices, and make sure everything is in proper working condition.
6. Make sure you understand the crane circuits and power distribution as well as the function setting of remote controller, to avoid incorrect wiring.

3-2 Transmitter Installation Instructions

Installation of batteries in the transmitter:

Insert batteries in proper direction into battery compartment. Attach and screw the battery cap on the bottom of the transmitter.

3-3 Receiver Installation Instructions

3-3-1 Preparation for Installation

1. Provide all necessary tools.
2. Select a proper location.
 - a. Select a stable place.
 - b. Select a place where you can see the Receiver or Antenna.

- c. Select a place where there is no spark, e.g. keep away from motors, relays, magnetic switch and power cables.
- d. Keep away from high-voltage wiring and device.
- e. The Receiver's box must be at least 3 cm away from the other obstacles.

3. Installation of proper power source

- ✎ The input power source for receiver can be 48 VAC 50/60 Hz, 110VAC, 50/60 Hz or 220VAC, 50/60 Hz., or 380VAC, 50/60 Hz. After power source is confirmed, one must connect the connector of initial coil of transformer to the relay module properly.

3-3-2 Installation Sequence

1. Turn off the main power for crane.
2. Drill the holes for screws, install receiver and then fix the receiver with 6mm screw nut on vibration- Resistant.
3. Connect the cable-assembly (provided) to the receiver and tighten the cables.
4. Connect cables to the control circuit of crane according to the receiver's wiring table and control contacts diagram.



Note:

Inspect and make sure that all wires are connected correctly.

5. Secure the cables between the receiver and crane so that cable cover (wrapper) will not wear out due to the vibration of the crane

3-3-3 Control Contacts Diagram

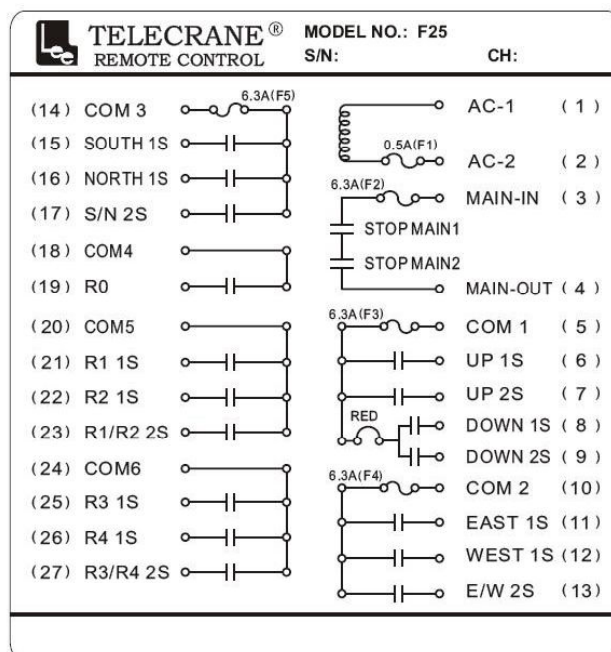

3-4 Power Supply and Change power supply voltage

F25 receiver provides with 4 kinds of Transformer (24V/42V/230V 、 48V/110V/220V 、 110V/220V/380V 、 48V/220V/380V) that allows user to choose based on the power input on site and the designated voltage will be set when the receiver is made in factory.

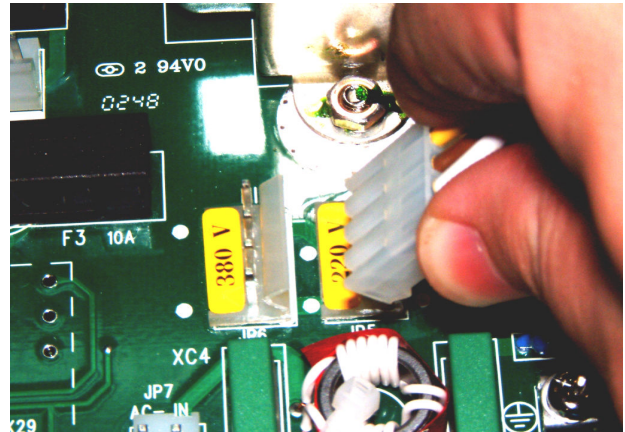
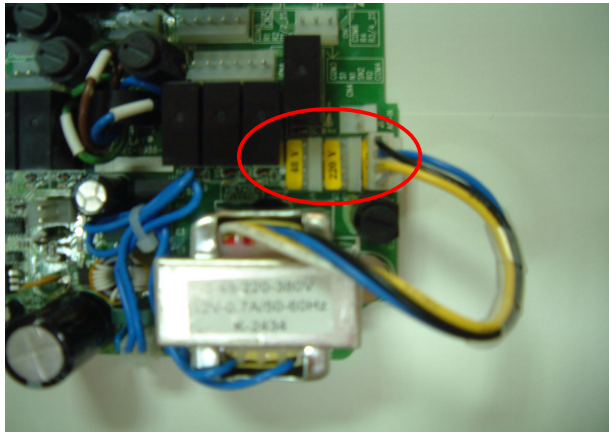

Changing power supply voltage

3-4-1 Disconnect the power of receiver.

3-4-2 Remove the connector plug of the transformer from its original position.

3-4-3 Insert the connector plug into the new position.

3-4-4 Complete the procedure.

Note:

Users are allowed to select the different power source according to the respective requirement. However, the transformer must be changed. Please check with your local distributor for replacement of the transformer if necessary.

3-5 Remote Channel Changing and Remote Pairing

Note: Before operating, one must make sure that the communication status between transmitter and receiver is at good condition.

3-5-1 Remote Channel Changing

Remote Channel Changing allows the transmitter to notify the receiver to perform the channel changing by radio remotely. After receiving the command from the transmitter, the receiver will automatically search and select a clear and suitable channel of frequency. In the mean time, the channel of frequency selected by the receiver will be sent back to transmitter and replace the original channel with this new one. The followings are the procedure of Remote Channel Changing:

1. Depress EMS mushroom pushbutton and turn the rotary key to “OFF” position.
2. Depress “START” pushbutton and hold it down, then turn the rotary key from “OFF” to “ON” position simultaneously. At this time, LED will fast flash in red, yellow, and green color alternately. This indicates that the transmitter is in the remote setting mode.
3. Press the “UP” pushbutton. At this time, LED will change to flash in yellow quickly. This indicates that it is performing the Channel Changing function.
4. When LED changes to flash 4 times in green and goes off, then the Channel Changing is completed. If LED changes to flash 4 times in red, then the Channel Changing is failed. You must go back to step 1 and redo the procedure again.
5. After completing the Channel Changing, turn the rotary key from “ON” to “OFF” position and follow the correct power on procedure. Then, the controller is ready to be normally used again.

3-5-2 Remote Pairing

Remote Pairing allows the transmitter to actively search the receiver to be paired on site. After confirming the receiver, the data saved in the receiver, including the functions settings, ID Code, and the Channel setting, will be download to the transmitter by radio. In this way, the trouble and the risk of climbing to the receiver can be eliminated. The procedures are as follows.

1. Depress EMS mushroom pushbutton and turn the rotary key to “OFF” position.
2. Depress “START” pushbutton and hold it down, then turn the rotary key from “OFF” to “ON” position simultaneously. At this time, LED will quickly flash in red, yellow, and green color alternately. This indicates that the transmitter is in the remote setting mode.
3. Press the “DOWN” pushbutton. At this time, LED will change to fast flash in green and red color alternately. This indicates that it is performing the Remote Pairing function and searching the receivers available on site.
4. When LED changes to flash in green, it means that it has found a receiver ready to be paired.
5. At this time, you may press the “START” pushbutton to confirm that the receiver is the one to be paired. The power-on indicator of the receiver that has been searched will be turned on and the horn will also make a sound at the same time.
6. If the receiver is not the one to be paired, then press “DOWN” pushbutton to skip it and go back to step 4 to continue the searching process for the next receiver.
7. If the receiver is the one to be paired, then press “UP” pushbutton to continue the procedure. At this time, LED will change to flash in yellow. It means that the transmitter is downloading the data from the paired receiver.
8. When LED turns to green, then press “UP” pushbutton to conclude the procedure above. At this time, LED will change to flash in green 4 times and go off. It means that the Remote Pairing is completed.

9. After completing the Remote Pairing, turn the rotary key from “ON” to “OFF” position and follow the correct power on procedure. Then, the controller is ready to be normally used again.

P.S. If the transmitter did not find any receiver, LED will flash in red 4 times and go off. It means that the Remote Pairing is failed and need to restart the procedures again.

3-6 Function Setting

The radio data can be read and written by using Copier or F25 software through PC.

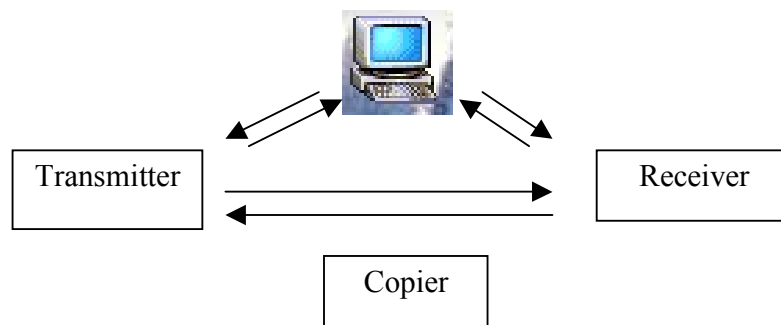

*Please refer to the copier user manual for more detail.

This remote control system can be set according to the working condition and operator’s need for the following promotes: pushbutton function, EMS neglected function, search function, interference neglected time...etc. This enables the remote controller to perform the most effective operation and to provide the safest operation. Please refer to the Software Function Setting in Chapter 4, next chapter.

Chapter 4 Software

4-1 Software Installation

F25 Software Installation

1. Insert F25 CD-ROM, the installation program will be executed automatically.

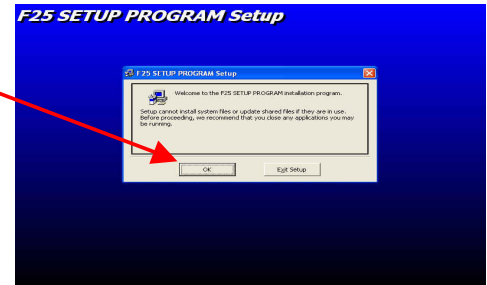

2. Press the “icon” and continue the installation

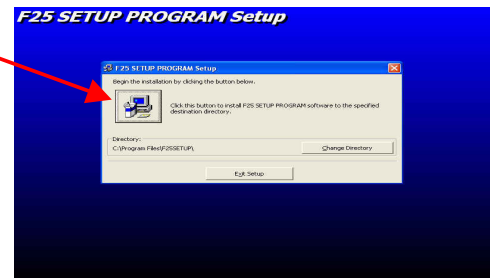

3. Press “Continue” button

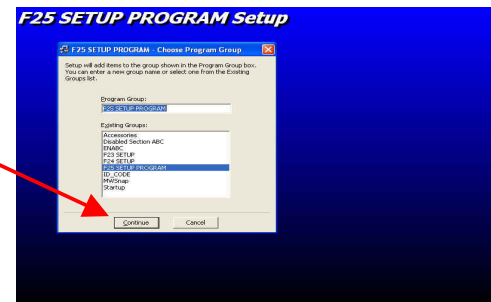

4. Press “OK” button and installation of F25 software program is completed.

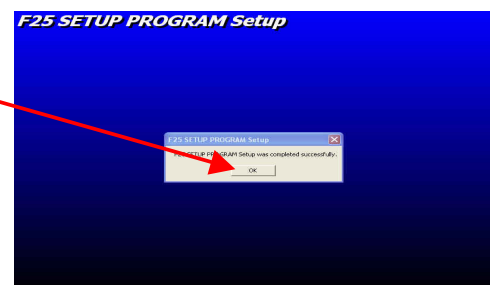

How to start F25 Program

1. Press “Start” button
2. Select “Programs”
3. Select “F25 SETUP PROGRAM”
4. Then select “F25 SETUP PROGRAM”

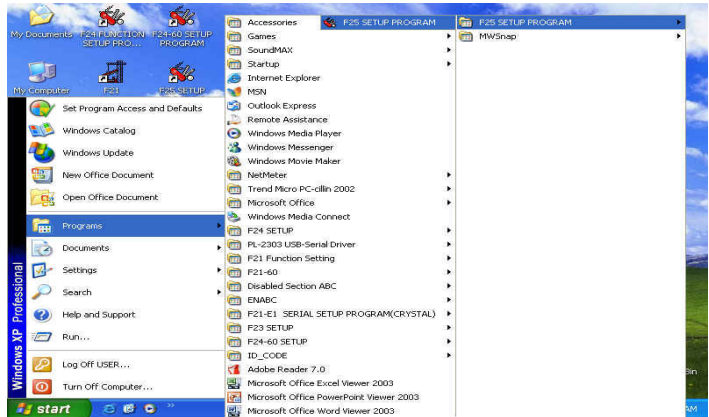

How to use F25 Program

Note: Make sure both power of transmitter and receiver is remaining OFF when reading or writing the data.

Reading Data

1. Connect program Interface Cable (USB) into transmitter or receiver.
2. Press “Read R/C”.
3. Press “OK” when finish.



Writing Data

1. Connect program Interface Cable (USB) into transmitter or receiver.
2. Press “Write R/C”.
3. Press “OK” when finish.



Pushbutton function setting

1. Read data from Transmitter (Receiver).
2. From main (Function-Setting) page, press any button group you would like to program. The pushbutton function table will be pop up immediately. Select any function block from the table (as shown on the figure). Return to main page automatically when finish the selection.
3. Repeat the above procedure 1~3 if you wish to make any other function changes on the pushbutton.

Remark: (1) For further information about the function definition, please refer to the annex 1 for more detail.

(2) Press “EXIT” to close function table without change

Print

To print the screen

Press **Printing**  button

Note: Only in-use page will be printed when pressing printing button. In order to print other page, please switch to another page and press the print button again.

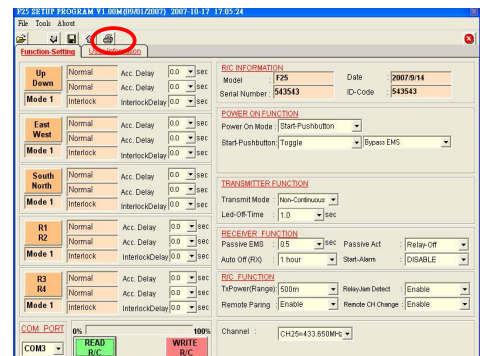

Exit F25 Program

Press exit button

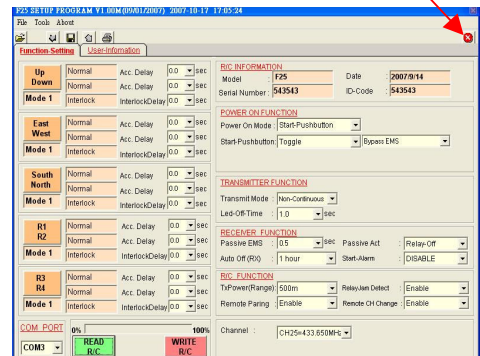

4-2 Definition of Function Setting Terms

Normal	The relative relay is “ON” when the pushbutton is pressed and held; and relay is “off” when the pushbutton is released.
Toggle	Maintained function: the relay is operated by pressing and releasing. Press the pushbutton and release once for “on”; press and release again to turn off the relay.
ON/OFF	Both pushbuttons are used to operate the same relay. Press the ON pushbutton to activate the relay and press the OFF pushbutton to de-activate the relay.
Interlock	The two pushbuttons are interlocked; it’s not possible to operate two opposite functions at same time.
Non-Interlock	The two pushbuttons can be operated at the same time: When the application allows operating at the same time two functions which are usually opposite to one another.
Interlock Delay Time	“Interlock Delay Time” is delay time between 2 opposite pushbuttons are being press one after another. i.e.: while crane is moving one direction (forward), moving opposite direction (backward) immediately would be dangerous specially when crane is hooking up the heavy object. The object may sway if crane does not completely stop before moving into opposite direction. Therefore the interlocked delay time could potentially prevent it. Normally, the interlocked delay time should be larger than the duration of crane stop.
Bypass EMS	“Bypass EMS” means that the relay relating to pushbutton will not be controlled by EMS mushroom or emergency stop signal.
Control By EMS	“Control by EMS” means that the relay relating to pushbutton is controlled by EMS mushroom or emergency stop signal.
Acc. Delay	This function uses to set the time interval between acceleration relay (i.e. conduction-delayed time of acceleration relay). It is suitable for accelerative operation only in order to prevent the cranes directly runs to highest speed to damage the motor.

Dual Motor	<p>When 1st step pushbutton is pressed, the 1st step relay turns ON, if 2nd step is being pressed then 2nd step relay turns ON and 1st step relay turns OFF. (For dual motor hoist)</p> <table border="1" data-bbox="592 371 1281 611"> <tr> <td data-bbox="592 371 868 501">Relay Pushbutton</td> <td data-bbox="868 371 1075 501">1st Step Relay</td> <td data-bbox="1075 371 1281 501">2nd Step Relay</td> </tr> <tr> <td data-bbox="592 501 868 555">1st Step</td> <td data-bbox="868 501 1075 555">ON</td> <td data-bbox="1075 501 1281 555">OFF</td> </tr> <tr> <td data-bbox="592 555 868 611">2nd Step</td> <td data-bbox="868 555 1075 611">OFF</td> <td data-bbox="1075 555 1281 611">ON</td> </tr> </table>	Relay Pushbutton	1 st Step Relay	2 nd Step Relay	1 st Step	ON	OFF	2 nd Step	OFF	ON
Relay Pushbutton	1 st Step Relay	2 nd Step Relay								
1 st Step	ON	OFF								
2 nd Step	OFF	ON								
Dual Motor (1)	<p>The main function characteristic of Dual Motor (1) is same as Dual Motor except the 1st step relay will not be activated (bypass) while pushbutton is returning from 2nd step to 1st step.</p>									
Combination	<p>When 2 buttons are being pressed simultaneously, it would result for an additional relay output (as toggle) to suit some of the special application such as lighting system.(No any extra pushbutton required to save the space and cost) <i>*Combination setting is prohibited for magnetic devices.</i></p>									
Magnetic ON/OFF	<p>Both pushbuttons are used to operate the same relay. Press the “Magnetic ON” pushbutton to activate the relay. If the operator wants to de-activate the relay, he must keep pressing the “Magnetic ON” pushbutton and then press the “Magnetic OFF” pushbutton in the mean time. The purpose is to prevent the operator from accidentally pressing the “Magnetic OFF” pushbutton and dropping the load held by the magnetic sucking disc.</p>									
R1,2,3 Toggle, R4 Normal	<p>R1, R2, R3 pushbuttons are set as Toggle and R4 pushbutton set as Normal. This function is applied when the crane has 2 trolleys and need to control the trolleys separately or simultaneously. Press R1 pushbutton to control Trolley A, Press R2 pushbutton to control Trolley B, and Press R3 pushbutton to control both Trolley A & B. Furthermore, R4 can independently perform the Normal function and with 2 speed.</p>									
R1,2,3 Toggle, R4 Toggle	<p>R1, R2, R3 pushbuttons are set as Toggle and R4 pushbutton set as Toggle. This function is applied when the crane has 2 trolleys and need to control the trolleys separately or simultaneously. Press R1 pushbutton to control Trolley A, Press R2 pushbutton to control Trolley B, and Press R3 pushbutton to control both Trolley A & B. Furthermore, R4 can independently perform the Toggle function.</p>									

R1,2,3 Toggle, R4 No Use	R1, R2, R3 pushbuttons are set as Toggle and R4 pushbutton no use. This function is applied when the crane has 2 trolleys and need to control the trolleys separately or simultaneously. Press R1 pushbutton to control Trolley A, Press R2 pushbutton to control Trolley B, and Press R3 pushbutton to control both Trolley A & B (Once R3 pushbutton is pressed, R4 relay is also activated with R3 relay. At this time, R4 pushbutton is no longer available even if it has been pressed.
R1,2,3 Toggle, R4 Group	R1, R2, R3, and R4 pushbuttons are all set as Toggle. This function is applied when the crane has 4 trolleys and need to control the trolley A, trolley B, trolley C, trolley D separately by pressing each individual pushbutton respectively.
Power On Mode	Start-Pushbutton/Password: Start-Pushbutton: It is the regular way to power on the receiver. Password: The selection menu of key1, key2, key3, and key4 are popped up when Password is chosen. Allow the operator to select any combination of these 4 keys. Operator has to enter password before turning on the transmitter. The purpose is to prevent the unauthorized person from operating the remote controller or machine.
Inching	The relative relay will be conducted within a certain time, in order to operate with short and precision movement. There are 2 ways to perform this function: Dual Buttons Inching: Press and hold “START” pushbutton and press the relative motion pushbutton to perform inching motion. (When “Dual Buttons Inching” is chosen.) Single Button Inching: Once “START” pushbutton is pressed, just presses the relative motion pushbutton, then can perform inching motion. To release this function, just press “START” pushbutton again. (When “Single Buttons Inching” is chosen.)
Inching time	“Inching time” can be set from 0.01~2.0 seconds. This function is used to operate crane with short and precise movement (e.g. accurate position). “Inching Time” is the same as the working time for the relative relay that is controlled by executing “Inching” control function.

Transmit Mode	<p>“Non-continuous transmitting mode”: After “Power-On”, the transmitter will transmit the signal only when the pushbutton is pressed. This mode can save the power of transmitter.</p> <p>“Continuous transmitting mode”: Transmitter will continuously transmit signal once transmitter is being Power-On.</p>
Save Power	This function is used to turn off the Transmitter after a given idle time. *Only available under “continuous transmitting” mode.
Auto-OFF(TX)	This function refers to turn off the Transmitter after a given idle time while transmitting the signal to switch off the receiver main relay. *Only available under “continuous transmitting” mode.
LED OFF-Time	This setting allows you to select the LED intermittent time to save transmitter power. i.e.: If 1 second is selected, the LED will be lighted every 1 second.
Passive Act	<p>This function ensures safe operations, including when there are disturbances that may affect the normal operating conditions. This assures that when the machine operates, the control is not subject to temporary and unexpected stops. Possible short interferences are bypassed. The passive act can be select in 2 mode as below,</p> <p>“Ry Off” If the interferences are larger than the pre-set time, the receiver will turn off all the relays under “NORMAL” function except the MAIN relay.</p> <p>“Power-Off” If the interferences are larger than the pre-set time, the receiver will turn off all the relays under “NORMAL” function and “Control by EMS” including MAIN relay. The receiver must be restart to operate again, follow the “Power-On” procedure to restart the system.</p>
Passive EMS	This setting allows the user to select the duration for the interferences to be bypassed. If the interferences were within the duration, then the receiver is still in operation, not affected. When the interference is longer than the duration, then the receiver will stop working. Usually, this action is called “Passive EMS”.
AUTO OFF (RX)	This function refers to turn off receiver after a given idle time. Receiver MAIN relay will be turned off automatically. Normally this function is cooperated with “non-continuous “transmitting” mode to prevent any unintentional radio.

Start-Alarm	This function allows the user to activate the alarm of the receiver to work or not to work. If the “Enable (2 sec)” is chosen, then the alarm will make a 2-second sound when the receiver is powered on/off.
TxPower(Range)	The emission power of the transmitter is adjustable according to the user’s requirement. This options is shown as transmission distance ranging from 20m to 500m, 8 steps to choose. The transmission distance is strictly subject to the local environmental factors. Therefore, it might be different from place to place and it is for reference only.
Jam Detect	This function is to allow the user to activate the “relay jam detect circuit” of the motion relays, UP/DOWN, EAST/WEST, SOUTH/NORTH, or not. If the option “Enable” is chosen, then the circuit is activated and it will control the EMS relay to stop working when the jammed relay is detected.
Remote Channel Changing	When the option “Enable” is chosen, then the “Remote Channel Changing” is allowed to perform. See Section 3-5-1 for the procedure of remote setting. When the option “Disable” is chosen, then the “Remote Channel Changing” cannot be performed.
Remote Pairing	When the option “Enable” is chosen, then the “Remote Pairing” is allowed to perform. See Section 3-5-2 for the procedure of remote setting. When the option “Disable” is chosen, then the “Remote Pairing” cannot be performed.
Channel	This setting allows the user to choose the Operating Frequency for the remote controller. There are 70 channels in total can be selected, CH1~CH70.