

ALARM ANNUNCIATORS



Minilec Microprocessor Based Alarm Annunciators are designed to keep an alert & watchful eye on your plant & processes. The entire range has been designed with an insight into the modern day manufacturing plant & its future requirements. Minilec Alarm Annunciators are equipped with microprocessor-based design, super bright LED facia windows, site selectable, programmed sequences as per ISA standard & thoughtful provisions for troubleshooting & maintenance. Dynamic, Alert & Responsive... These unique advantages have helped the Minilec Annunciators to be an icon in the power T & D industry & engineering establishments in India. The world class Minilec Annunciator has made its presence felt in Overseas markets.

MODELS

**MICROWARN 0600,
MBAS 0600,
MBAS 9700,
MBAS 9900,
MBAS 08,
Annunciation Panels, Microfacia**

FEATURES

- 4 windows to 128 windows
- Integral & Split models
- Microprocessor based
- Super bright LEDs for facia
- Standard operating sequences
- Any other custom- made sequences
- NO-NC & Trip Non-Trip site selectable
- Repeat relays
- Supply fail annunciation / Indication
- Choice of 3 window sizes
- Choice of five colours
- RS 232 / RS 485 Output Port

FUNCTIONS

- Continuous monitoring of input parameters
- Control of process through outputs & software
- Data acquisition & communication
- Data Storage & records through PC



Ordering Instructions

- ✓ Product Family Name
- ✓ Model Name
- ✓ Aux. Supply / Control supply voltage
- ✓ No. of Inputs (Windows)
- ✓ Operating sequence

ALARM ANNUNCIATORS

MBAS 0600

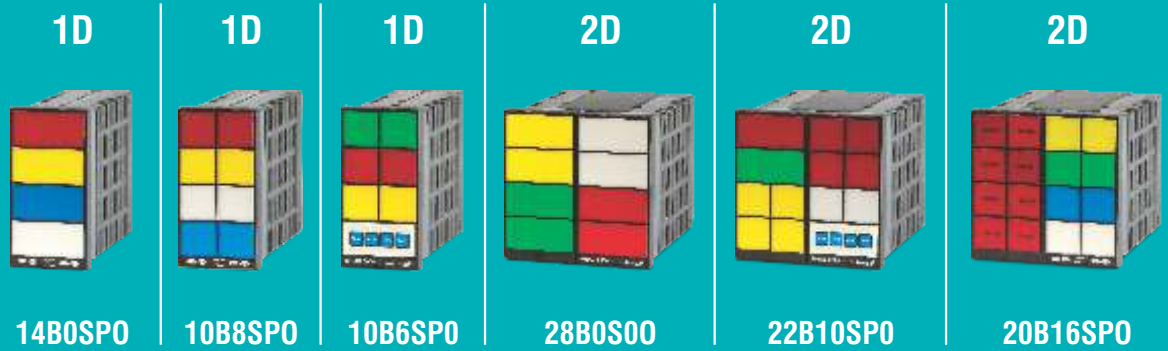

MBAS 0600 is a improved version of earlier MBAS 9400, and is available for 4 to 32 windows

The Functional Features

- Fixed Sequence (S1/S2/S3/S4)
- Potential free dry contact inputs
- NO/NC inputs selectable configuration
- Relay output for external Audible Hooter 3rd Relay (optional) for either of below mentioned features
 - a) Ring back hooter
 - b) Supervisory control
- Minilec Standard Communication Protocol

The Design Features

- Single chip microcontroller logic
- Opto isolated inputs and outputs
- Super Bright LED window illumination
- High Noise immunity / isolation
- Switch mode power supply
- Self surveillance watchdog LED

The Constructional Flexibility

- Conforming to DIN panel cutouts
- Replaceable snap-on window capsules
- Two different window size
- Moulded enclosures

System Enclosures

The MBAS 0600 annunciation systems is configured in multiples of four basic ABS moulded enclosures



Basic Standard Enclosures

Optional Features

- Any custom built operating sequences
- Manned / Unmanned function
- MODBUS RTU/ASCII Protocol

- Fault Follower contact output per fault Input (NO or NC)
- Supply fail indication / annunciation Built-in
- Built-in control push buttons

Back view showing Terminal details

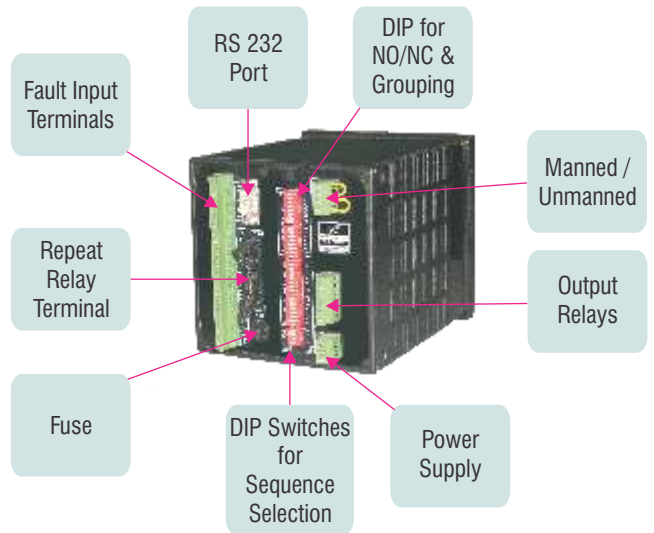

Functional Block Diagram

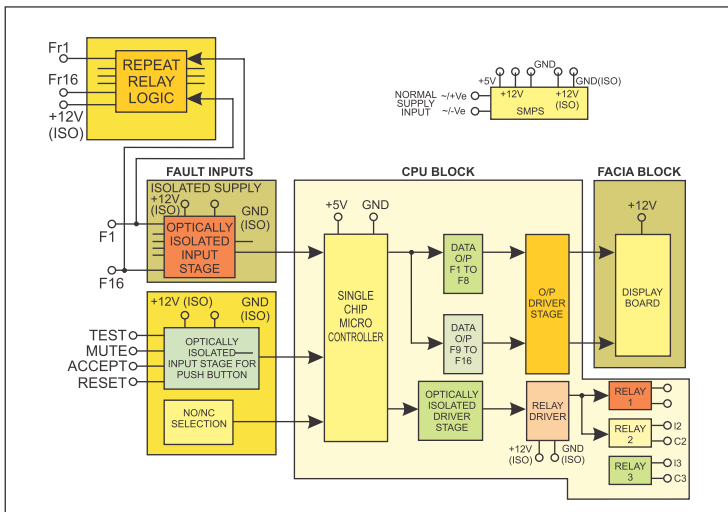

PC Side software

MBAS 0600



3D



312B0SPO

3D



30B24SPO

4D



416B0SPO

4D



40B32SPO

Connection Diagram (FOR MAX. 32 POINT MBAS 0600.)

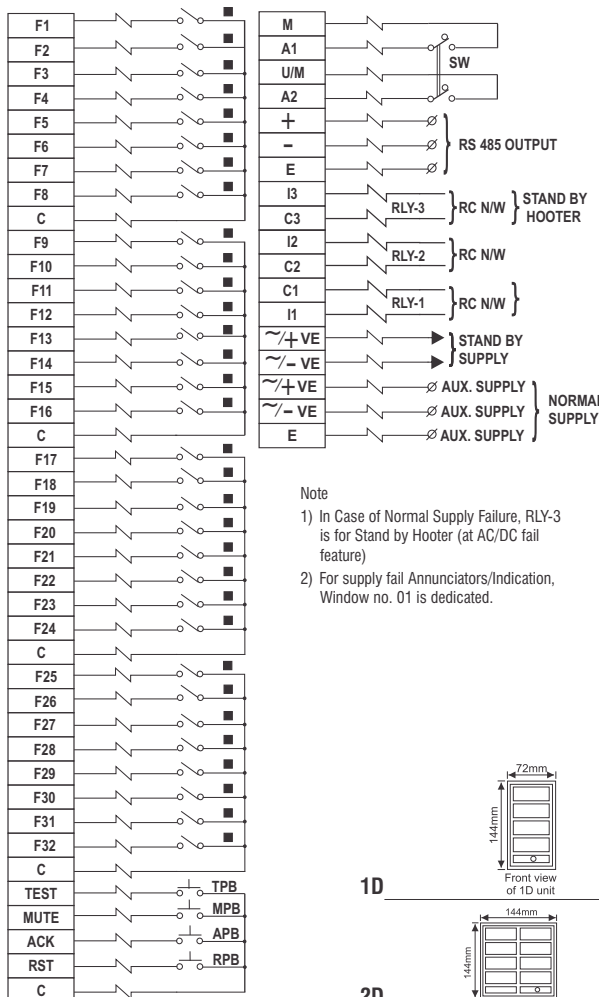

TECHNICAL SPECIFICATIONS :

Supply Voltage	24 / 30 / 48 / V DC, 20-60 V AC/DC, 90-270 V AC / DC
Windows	4 / 6 / 8 / 12 / 16 / 18 / 22 / 24 / 32
Window Sizes	30 x 30mm / 30 x 65 mm
Display Device	Super bright high efficiency low power consuming LED's
Facia Type	Individual windows lens Front Replaceable
Window Colours	RED, Yellow, Green, White & Blue
Flash Rate	Fast - 60 flashes/min. Slow - 30 flashes/min.
Response Time	40 msec.
Input Signal	Potential free contacts (NO or NC site selectable)
Grouping	Trip / Non Trip site selectable
Interrogation Voltage	+ 12 V DC
Output Contacts	1 NO + 1 NO + 1 NO (optional)
Architecture	Integrated
Operational Sequences (site selectable)	Auto/Manual/First-up/Ringback (optional) OR any other sequence on request
Operational Temp.	0-60 degrees C
Power Consumption	1.5 Watts per Window (Max)
Optional	AC-DC fail Annunciation or Indication / Repeat Relays / RS232 - 485 Port
Dimensions (mm)	1D 2D 3D 4D
Panel Cutout (L x W)	138 x 68 138 x 138 138 x 210 138 x 282
Overall (L x W x D)	144 x 72 x 215 144 x 144 x 215 144 x 216 x 215 144 x 288 x 215

Wherever not specified Contact Rating : 5A @ 230 V AC (resistive) * CE marked products available on request.

Dimensional & Panel Cutout Details

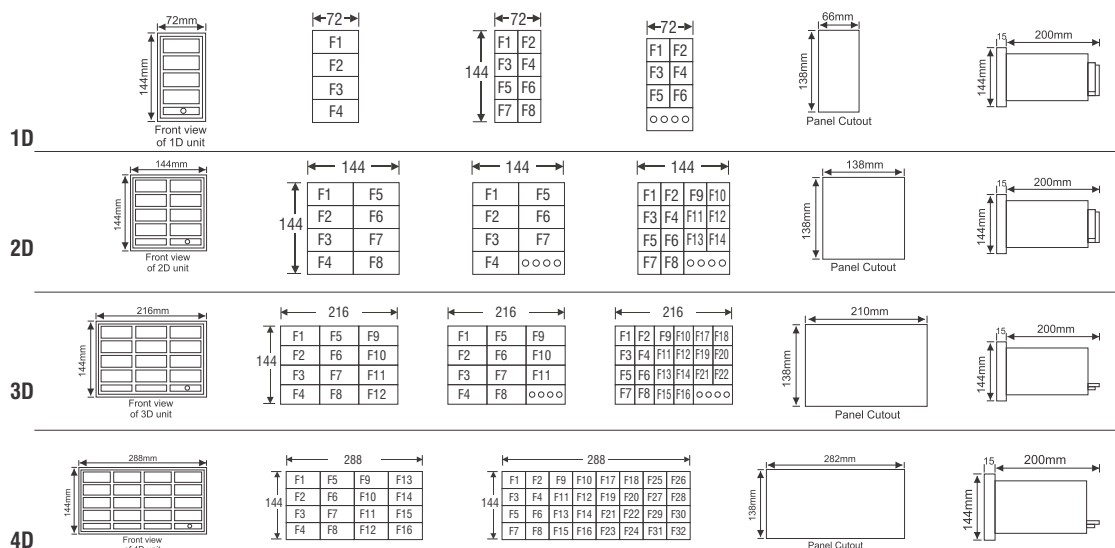

ALARM ANNUNCIATORS

MBAS 9700



PSU Rack



MCU Rack

CONSTRUCTIONAL DETAILS

MBAS 9700 consist of four basic sections

- 1) The Power Supply Unit (PSU Module).
- 2) The Main Control Unit (CPU + IOU Module).
- 3) The Display Facia Unit (DFU Module).
- 4) Computer interface.

THE MAIN CONTROL UNIT (MCU)

CPU module is the Main Processing Unit of MBAS 9700 which scans and processes the incoming fault signals from the various potential free field contacts through IOU module, and drives the corresponding LED windows and the audible device in order to annunciate the fault through IOU module. The IOU module is the input & output interfacing unit. To each IOU module 16 input contacts (potential free) & 16 window LED's can be connected.

STANDARD FEATURES

- Single chip micro-controller logic.
- Super bright LED's for window illumination.
- Site selectable NO/NC type fault contacts.
- Site selectable trip /Non trip (Grouping).
- Easy card replacement & hence fault diagnosis.
- Switch Mode Power Supply. (Suitable for Both AC/DC Supply)
- High noise immunity and wide input supply variation.
- Opto-isolated Inputs and Outputs.
- Site Selectable sequences.
- Potential free dry input contacts.
- Two different window sizes.
- Replaceable window lens & window legends.
- Computer linking for fault logging with printer facility for report.
- Self-surveillance watch dog LED.
- Relay output for external audible hooter.
- Diagnostics Menu
- Redundant Power Supply (Only in 19" Rack Model)
- CPU fail & PSU fail indication with relay output contact (Only in 19" Rack)
- User Friendly terminal Connectors

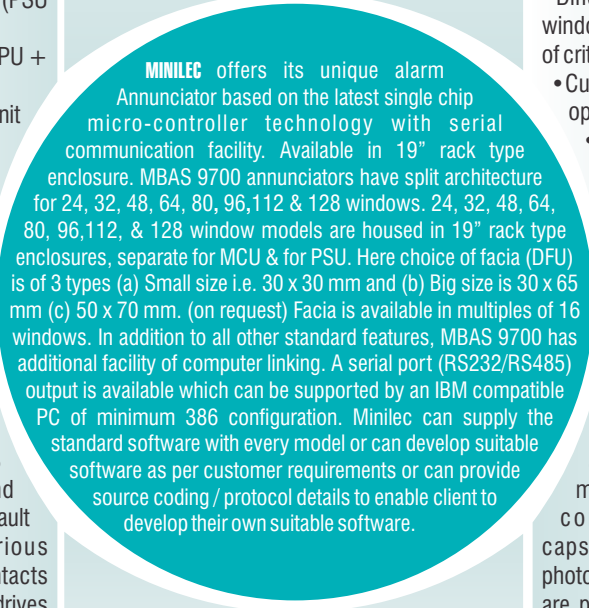

MINILEC offers its unique alarm Annunciator based on the latest single chip micro-controller technology with serial communication facility. Available in 19" rack type enclosure. MBAS 9700 annunciators have split architecture for 24, 32, 48, 64, 80, 96, 112 & 128 windows. 24, 32, 48, 64, 80, 96, 112, & 128 window models are housed in 19" rack type enclosures, separate for MCU & for PSU. Here choice of facia (DFU) is of 3 types (a) Small size i.e. 30 x 30 mm and (b) Big size is 30 x 65 mm (c) 50 x 70 mm. (on request) Facia is available in multiples of 16 windows. In addition to all other standard features, MBAS 9700 has additional facility of computer linking. A serial port (RS232/RS485) output is available which can be supported by an IBM compatible PC of minimum 386 configuration. Minilec can supply the standard software with every model or can develop suitable software as per customer requirements or can provide source coding / protocol details to enable client to develop their own suitable software.

THE POWER SUPPLY UNIT (PSU)

PSU converts the available power source into a regulated and filtered DC output, which is fed to the MCU Module & DFUs. The power supply can accept Specified AC or DC I/P supply, depending upon the application. Redundant Power supply is available.

OPTIONAL FEATURES

- Different colored LED's in each window for easy differentiation of critical faults.
- Customized preprogrammed operating sequence.
- Multi channel serial communication (8 Annunciators & single computer)
- Repeat Relay Card

THE DISPLAY FACIA UNIT (DFU)

The Facia block is accessible from front (in moulded enclosure) and constitutes of window capsules. The sandwiched photo film window inscriptions are press fitted on the window capsules. For 24 to 128 points system the DFUs are given separately.

MBAS 9700

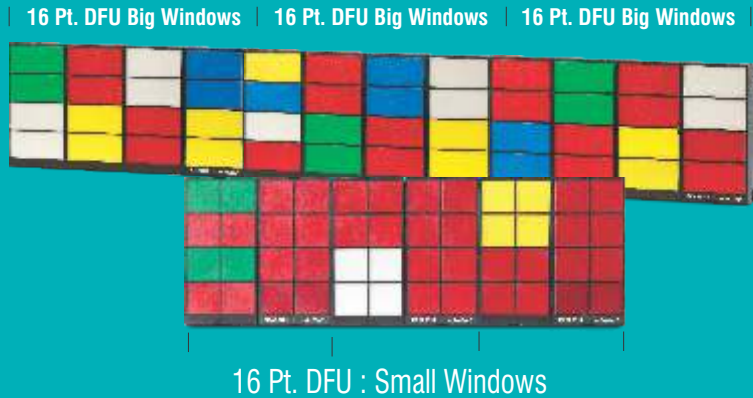

COMPUTER INTERFACE

The MCU unit transmits fault information to computer serially. RS232/RS485 standard is used for serial communication. Communication protocol modbus ASCII / RTU can be offered. In computer user-friendly software is written. This software offers on-line Date & Time setting, Legend setting, Display window & also it gives fault report with on demand printing facility.

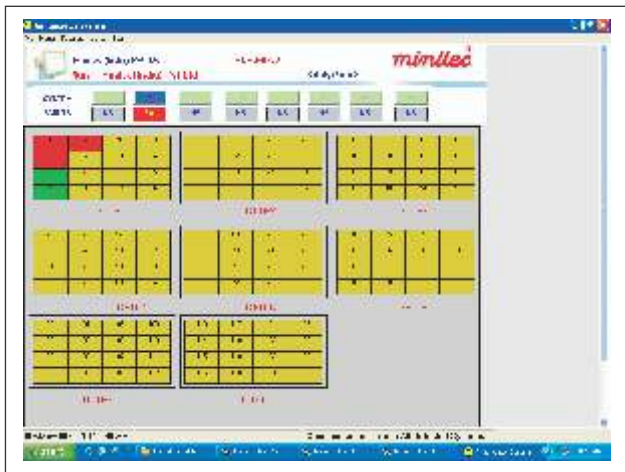

Dimensional Details for Facia

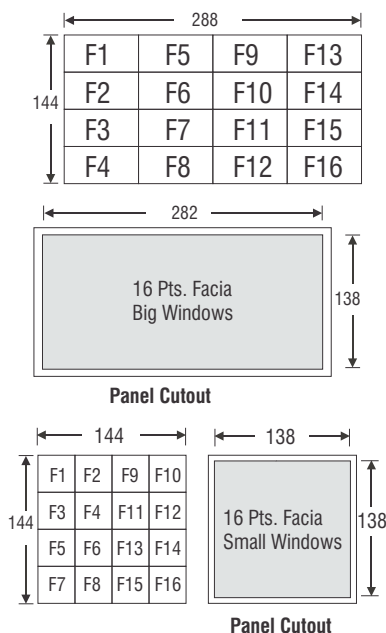

TECHNICAL SPECIFICATIONS:

1.0	Supply voltage	20-60VDC, 90 - 270VAC/DC
2.0	Supply frequency	50 / 60 Hz. (±3%) for AC
3.0	Input	
3.1	Fault Alarm Inputs.	Actuation Through Fault Contacts
3.2	Fault contacts.	Potential free (voltage free) type
3.3	Input interrogation voltage	+12V DC (ISO)
3.4	Input isolation	Opto isolating device. (2 KV)
3.5	Response Time	40 msec.
3.6	Site selectable DIP for	
	Fault type	NO/NC
	Grouping	Trip/Non Trip
	Sequence selection	Manual/Auto/Ring back (optional)/Firstup
4.0	Output	
4.1	Output contacts	1NO + 1NO + 1NO (optional)
4.2	Output contact for CPU & PSU fail	1NC
4.3	Contact Rating	5 amp at 240 VAC (Resistive)
5.0	No. of windows	24/32/40/48/64/80/96/112/128
5.1	Windows dimensions	30 mm x 30 mm For small windows 30 mm x 65 mm For big windows
5.2	Window Colours	Red/Yellow/Green/White/Blue
5.3	Flash rates	Fast flash - 50-60 flashes / Min Slow flash - 25-30 flashes / Min.
5.4	Power Consumption	1.5 W per Window. (Max)
6.0	Sequence	Manual, Auto, Ring back (optional), Firstup (Any Other Sequences On Request)
7.0	Serial communication	RS232/RS485 (with modbus ASCII/RTU) optional

ALARM ANNUNCIATORS - MBAS 9700

DIMENSIONAL DETAILS - MCU & PSU

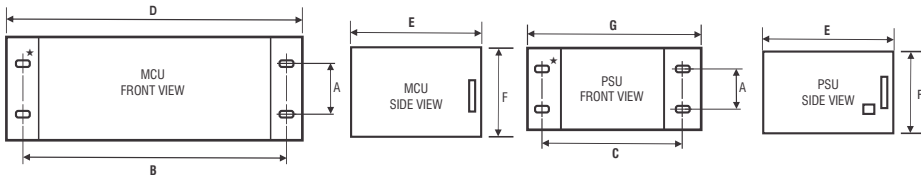

MCU & PSU for 24 to 64 windows are housed in one 19" rack.

Overall Dimensions (DFU)

MODELS	Big Windows		
	W	L	D
128 POINT	144m.m.	2304m.m.	70m.m.
112 POINT	144m.m.	2016m.m.	70m.m.
96 POINT	144m.m.	1728m.m.	70m.m.
80 POINT	144m.m.	1440m.m.	70m.m.
64 POINT	144m.m.	1152m.m.	70m.m.
48 POINT	144m.m.	864m.m.	70m.m.
32 POINT	144m.m.	576m.m.	70m.m.
24 POINT	144m.m.	432m.m.	70m.m.
	Small Windows		
128 POINT	144m.m.	1152m.m.	70m.m.
112 POINT	144m.m.	1008m.m.	70m.m.
96 POINT	144m.m.	864m.m.	70m.m.
80 POINT	144m.m.	720m.m.	70m.m.
64 POINT	144m.m.	576m.m.	70m.m.
48 POINT	144m.m.	432m.m.	70m.m.
32 POINT	144m.m.	288m.m.	70m.m.
24 POINT	144m.m.	216m.m.	70m.m.

MODELS	MOUNTING DIMENSIONS			OVERALL DIMENSIONS			
	A	B	C	D	E	F	G
128 POINTS	57.15	465.10	292.38	482.60	260.00	132.50	310.38
112 POINTS	57.15	419.38	292.38	436.88	260.00	132.50	310.38
96 POINTS	57.15	373.66	241.58	391.16	260.00	132.50	259.58
80 POINTS	57.15	327.94	241.58	345.44	260.00	132.50	259.58
64 POINTS	57.15	434.62	-----	452.12	260.00	132.50	-----
48 POINTS	57.15	388.90	-----	406.40	260.00	132.50	-----
32 POINTS	57.15	292.38	-----	309.88	260.00	132.50	-----
24 POINTS	57.15	292.38	-----	309.88	260.00	132.50	-----

PANEL CUTOUT DETAILS - DFU

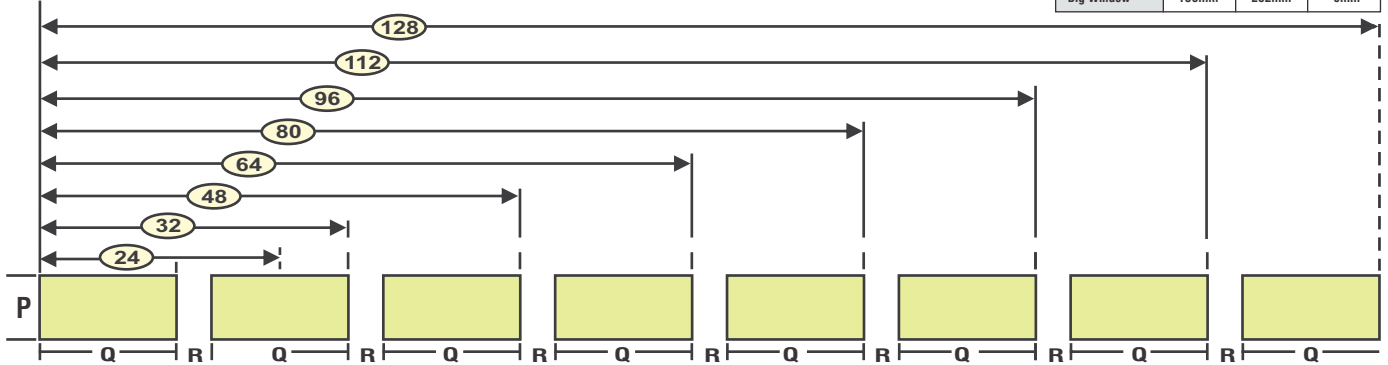

EXTERNAL WIRING DIAGRAM WITH REPEAT RELAY

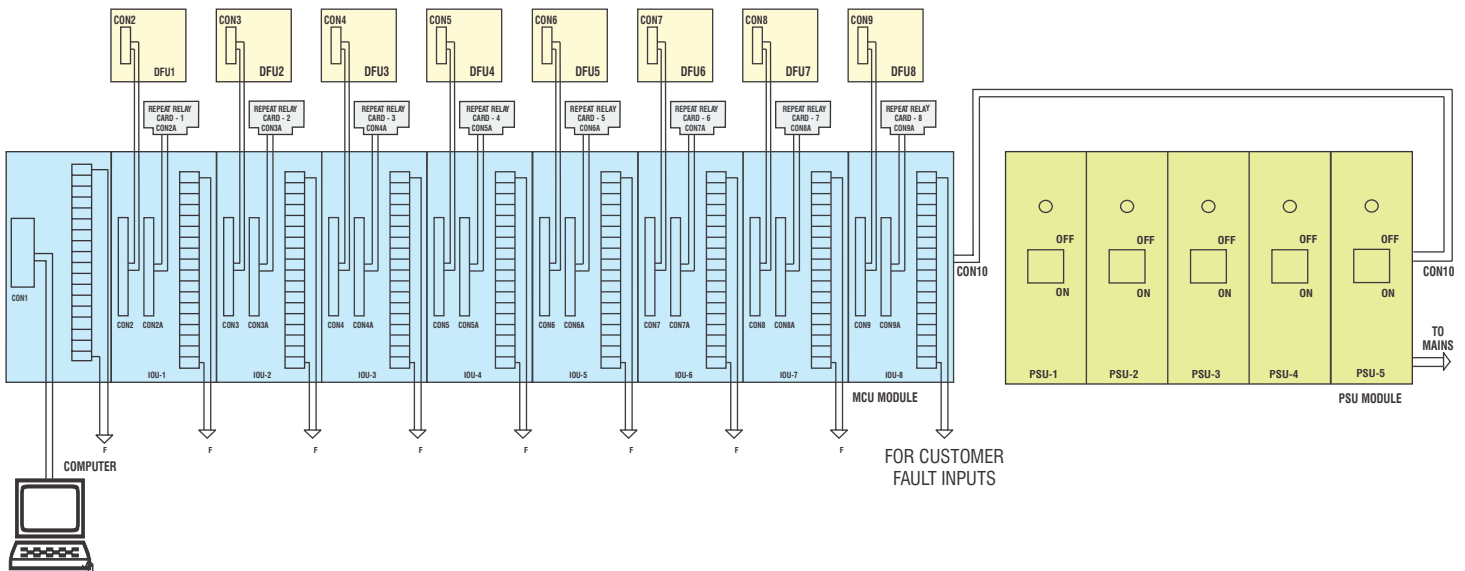



MBAS 08



4 Windows PB + 2 Buzzer



6 Windows PB + 2 Buzzer



7 Windows + PB



8 Windows

Most compact alarm Annunciator with improved window design and all major features of MBAS 0600 Annunciator. Models with built-in Buzzer & Push buttons also available.

Supply Voltage	90 to 270 VAC/DC 24 VDC /30 VDC /48VDC
Supply Frequency [FOR AC]	50 / 60 Hz ± 3%
Windows	4 / 6 / 7 / 8 [max]
Display (Window)	Window lenses replaceable Legends replaceable.
Window Dimensions	37 X 17 mm. 37 X 27 mm. for 4 Windows model only
Power Consumptions	1.5 Watts per Window (Max)
Flash Rate	50 - 60 Flash per min. in fast flashing 20 - 30 Flash per min. in slow flashing
Operating Sequence	S1, S2, S3, S4 (Site Selectable)
Other Features	<ul style="list-style-type: none"> • NO / NC and Grouping (Trip/Non trip) Selection • Supervisory Contact output.
Optional Features	<ul style="list-style-type: none"> • Any other operating sequence. • RS232 / RS485 Output • Man / Unmanned Feature. • Supply fail Annunciation
Input Signal	Potential Free contacts
Input Interrogation Voltage	+12 VDC
Window Colours	Red, Green, Yellow, Blue, White.
Output Contacts	1 NO + 1 NO [For Hooter] 1NO For Ring back or Supervisory contact (Optional)
Output Contact Rating	5 Amp, 240V AC (Resistive)
Inbuilt Push Buttons	4 NOS. (Test, Mute, Accept, Reset) Membrane type (Optional)
Communication	RS232 / RS485 (MODBUS RTU/ASCII) (Optional)
Operational Temp. Limit	-5°C to 60°C
Humidity	Upto 95% Rh
Enclosure	ABS moulded enclosure
Unit Dimensions	Overall (L x W x D) 96 x 96 x 76 mm Cutout (L x W) 92 x 92 mm
Weight	350gm

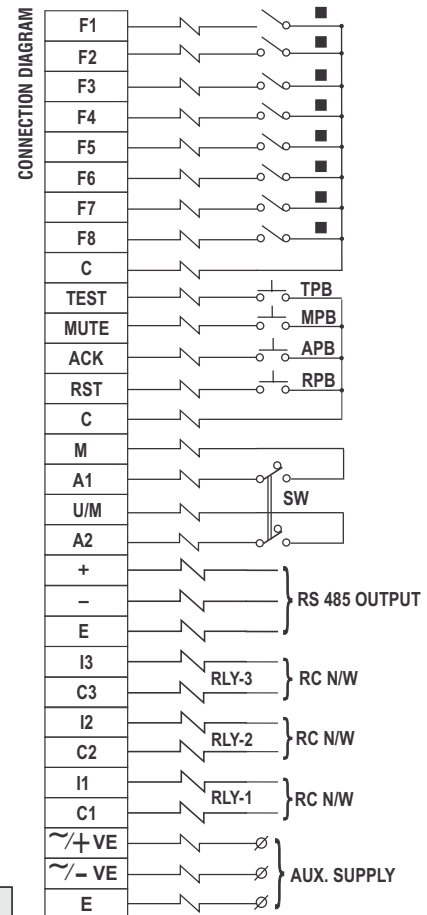

PROGRAMMING OF MBAS 08

SR. NO.	KEY OPERATION	MODE OF OPERATION	WINDOW STATUS	WDL STATUS
1	---	Normal Run Mode	As per operation	Flashing @ 1 flash/sec.
2	TEST + ACK Pressed (for 5 Sec.)	Sequence selection	Windows fast flashes for 2 to 3 sec. W1 - ON - S1 W2 - ON - S2 W3 - ON - S3 W4 - ON - S4	Flashing @ 1 flash/sec.
3	TEST + ACK Pressed (for 5 Sec.)	NO / NC selection	W - ON - NO W - OFF - NC	Off
4	TEST + ACK Pressed (for 5 Sec.)	Grouping selection	W - ON - Group 1 W - OFF - Group 2	Steady On
5	TEST + ACK Pressed (for 5 Sec.)	Device ID selection	As per chart in Manual	Fast Flashing
6		Auto exit after 10 Seconds		

OVERALL DIMENSIONS

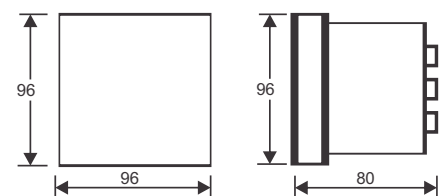

CUT OUT DIMENSIONS

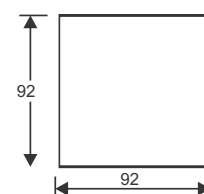

ALARM ANNUNCIATORS

MICROWARN 0600



12 Windows Model



8 Windows Model with push button

Now with Reduced depth

This is a modified version of earlier Microwarn 9600 model which has been discontinued.

Microwarn 0600 is now more compact than before with reduced depth. Also it can have 3rd output relay (optional) for extra function. Microwarn 0600 consists of 3 basic sections:

- (A) The Power Pack
- (B) The CPU
- (C) The Facia,

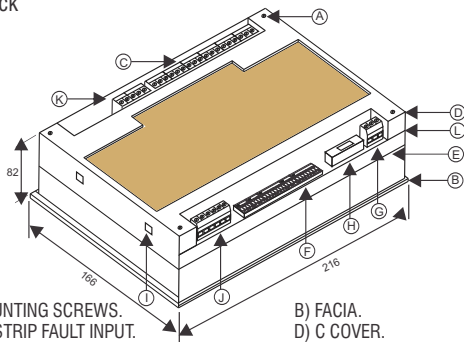

NOTES :-

- A) COVER MOUNTING SCREWS.
- B) FACIA.
- C) TERMINAL STRIP FAULT INPUT.
- D) C COVER.
- E) LED BOARD.
- F) DIP SWITCHES.
- G) POWER SUPPLY CONNECTOR.
- H) FUSE
- I) SLOT FOR MOUNTING CLAMP.
- J) RELAY OUTPUT.
- K) TERMINAL FOR EXTERNAL PUSH BUTTON.

A) The Power Pack :

The Microwarn 0600 is powered by a highly reliable and noise free, specially designed power supply. It converts the available power source (AC/DC voltage supply) into a regulated and filtered DC output, which is fed to the annunciator unit.

B) The CPU :

This is the Central Processing Unit of Microwarn 0600 which scans and processes the incoming fault signals from the various potential free field contacts and drives the corresponding LED windows and the audible devices in order to announce the fault, according to the operating sequence selected.

C) The Facia :

This section consists of facia windows illuminated by "Super Bright LEDs" on occurrence of any fault. The Super Bright LEDs ensure a long and absolutely maintenance free window life along with a good visibility, and have very low power consumption.

NO/NC T/NT or sequence selection DIP switches are located outside, hence programming is now possible without opening the unit.

Models of 12, 8, 6 windows are available. 8 and 6 window models are with built-in push buttons.

Optional Features:

- 3rd Supervisory Relay
- Built in supply fail annunciation

Note: For Microwarn 0600 with Built in supply fail annunciation over all dimensions will be
 Horizontal - 166 X 216 X 147
 Vertical - 216 X 166 X 147.
 Panel Cutout will same.

TECHNICAL SPECIFICATIONS:

Supply Voltage	24/30/48/ V DC, 20-60 V AC/DC, 90-270V AC/DC	
Windows	12/8/6	
Window Sizes	45 x 45 mm	
Display Device	Super bright high efficiency low power consuming LED's	
Facia Type	Front Replaceable	
Window/LED Colour	Standard colour available RED, Optional colours Yellow, Green	
Flash Rate	Fast - 60 flashes/min. Slow - 30 flashes/min.	
Response Time	40 msec.	
Input Signal	Potential free contacts (NO or NC site selectable)	
Grouping	site selectable (Trip / Non Trip)	
Interrogation Voltage	+ 12 V DC	
Output Contacts	1 NO + 1 NO (optional) + 1 NO	
Architecture	Integrated	
Operational Seq.	ISA Standards sequences - Auto/Manual/First-up/Ringback (optional) OR any other sequence on request	
Operational Temp.	-5°C to 60°C	
Power Consumption	1.5 Watts per Window (Max.)	
Optional	AC-DC fail Annunciation	
Dimensions (mm)	Horizontal	Vertical
	Panel Cutout (L x W)	203 x 153
	Overall (L x W x D)	216 x 166 x 82

Wherever not specified Contact Rating : 5A @ 230 V AC (resistive) * CE marked products available on request.

Dimensional Details

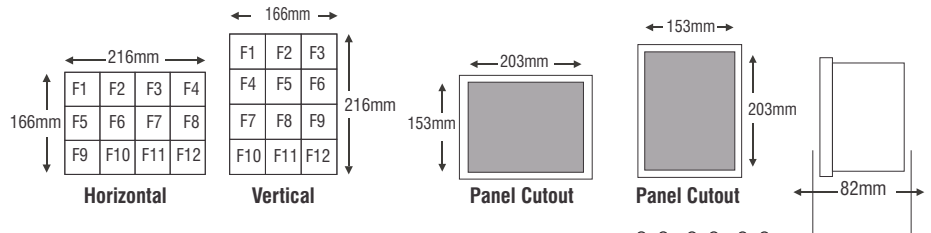

Typical Connection Diagram

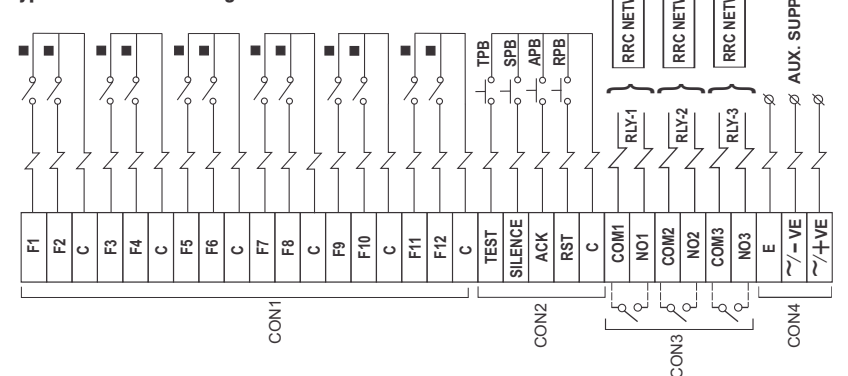

MBAS 9900

MICROFACIA



1 OB 6S PB

1 OB 4S PB

1 OB 4S PB

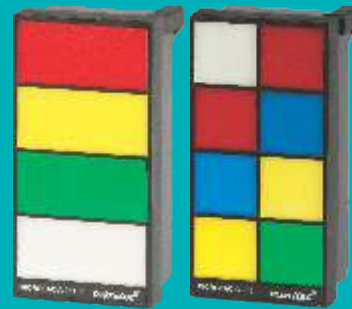

MF951

MF955

These are LED Facia windows with Potential input. Microfacia is available in either 4 Big or 8 Small windows size. Standard models available for 12V/24V DC and 110V/230V AC.

MBAS 9900 Annunciator accepts 12 / 24 V DC potential input & also provides control relay output. Added built-in buzzer & push buttons makes it complete Annunciator with control output. This output is interlocked until all fault input resets. MBAS 9900 is presently available in 4 point & 6 point small window (30 x 30mm) configuration. Both 4 point & 6 point systems come with built-in push buttons.

TECHNICAL SPECIFICATIONS:

PARAMETERS	
Supply Voltage	90-270 V AC/DC, 12 V/24 V DC +10% -15%
Windows	4 / 6 / 8
Window Sizes	30 x 30 mm
Display Device	Super bright LED's
Facia Type	Individual Windows Front Replaceable
Window Colours	RED, Yellow, Green, White, Blue
Flash Rate	Fast - 60 flashes/min. Slow - 30 flashes/min.
Response Time	40 msec.
Input Signal	+12 V or 24 V DC Contact
Output Contacts	1 CO + 1 CO
Architecture	Integrated
Operational Seq.	Sequence as mentioned in text
Operational Temp.	-5°C to 60°C
Power Consumption	1.5 Watts per Window

Wherever not specified Contact Rating : 5A @ 230 V AC (resistive)

Operating sequence table - MBAS 9900

MANUAL ACTION	N		ABN	RN	R-ABN	N		ABN	N	ABN	R-N	R-ABN	N	ABN
	P.B. TEST	DEP	REL	F	OFF	F	OFF	F	OFF	F	OFF	F	OFF	F
VISUAL AUDIO(N)	F	ON	OFF	ON	OFF	ON	OFF	ON	OFF	ON	OFF	ON	OFF	ON

ABBREVIATIONS :

N	NORMAL	AUDIO(N)	S. STEADY ON
ABN	ABNORMAL	DEP.	NORMAL BUZZER
RN.	RETURN TO NORMAL	REL.	DEPRESSED
RABNS	RETURN TO ABNORMAL	N.A.	RELEASED
		F	NOT APPLICABLE
			FLASH

Dimensional Details

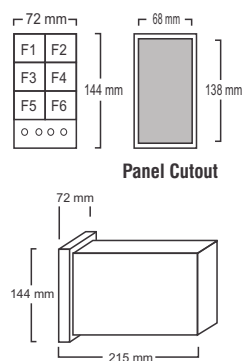

Connection Diagram

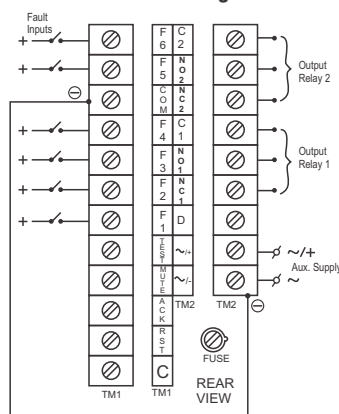

CONNECTION DIAGRAM

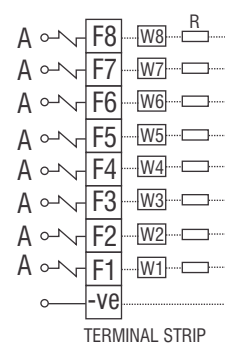

OVERALL DIMENSIONS

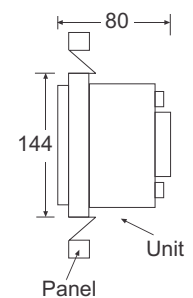

PANEL CUTOUT

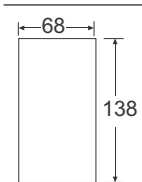

ALARM ANNUNCIATORS

STANDARD OPERATING SEQUENCES

The MINILEC Annunciation systems are programmed to operate as per following operating sequences conforming to ISA standards. Other sequences / non standard sequences are given as per customer's requirement.

Minilec Sequence Code	Operating Sequence Title	ISA Std. Code
S1	Manual Reset	M1
S2	Auto Reset	A1
S3	Ringback	R1-12
S4	First UP	F2M-1

SEQUENCE S1 : Manual Reset (M1)

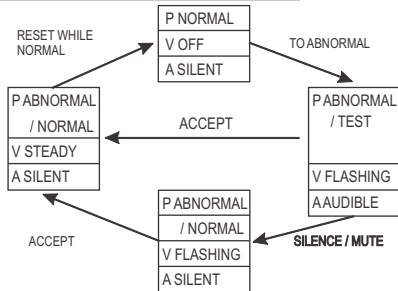

1. Test, Silence Accept, Reset Push Buttons are external.
2. Audible alarm can be silenced by pressing Silence (Mute) Push button.
3. Manual reset of Accepted faults after process conditions return to normal.
4. Operation test provided.

SEQUENCE S2 : Auto Reset (A1)

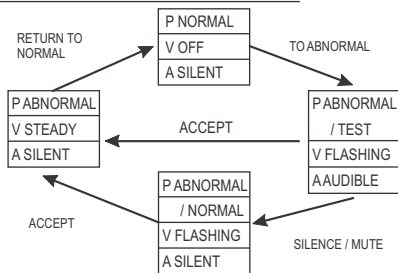

1. Test, Silence Accept, Reset Push Buttons are external.
2. Audible alarm can be silenced by pressing Silence (Mute) Push button.
3. Automatic reset of Accepted faults after process conditions return to normal.
4. Operation test provided.

SEQUENCE S3 : Ringback (R1-12)

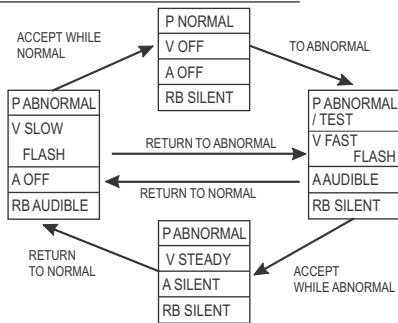

1. Test, Silence Accept, Reset Push Buttons are external.
2. Alarm & ringback Audible devices.
3. Audible device or ringback alarm can be silenced by pressing Silence (Mute) Push button.
4. Ringback visual & audible alarm when process status returns to normal.
5. Operation test provided.

SEQUENCE S4 : First Out Manual Reset (F2M-1)

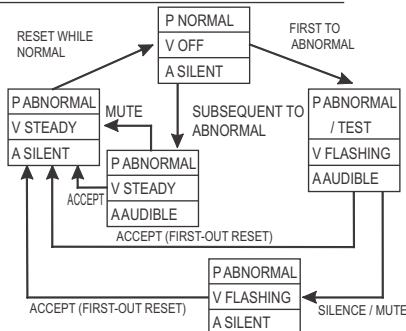

1. Test, Silence Accept, Reset Push Buttons are external.
2. First-out flashing and subsequent steady.
3. Manual reset of Accepted faults when process status return to normal.
4. Operation test provided.

Note: P : Process Status, V : Visual Alarm Status, A : Audible Alarm Status, RB : Ringback audible alarm status.

OPTIONAL ACCESSORIES

Repeat Relay Card

External Repeat Relay Cards can be connected for remote annunciation or interfacing with SCADA or DCS hardware. These cards are connected by plug-in type pre-fab cables. Repeat Relay Card is suitable for NO type Fault contacts only.

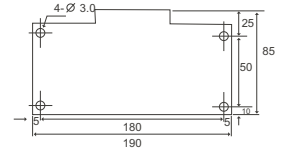
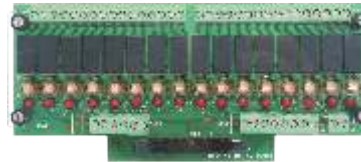

Manned / Unmanned Facility

This feature allows disabling the audio & visual indication on fault occurrence if the station is unmanned. The annunciator registers & records all faults occurring during unmanned mode and displays again manned mode.

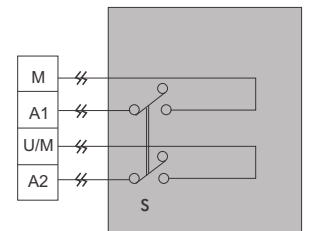

RS 232 / 485 Convertor

This is a universal convertor for converting RS 232 serial port to RS 485 serial port or vice versa. It operates on 230 AC supply and is to be used with Minilec make interconnecting cables for Minilec annunciators & for PC.



Electronic / Industrial Hooter

Electronic Hooters with tone & volume control are supplied. Suitable for AC or DC supply Standard 96 x 96 enclosure.

ANNUNCIATOR PANELS

Often Alarm Annunciators are required to be housed in a suitable cubical and many times such control panel consists of only Alarm Annunciators. Minilec offers Alarm Annunciators along with control panels. This includes design of control panel, fabrication, painting, assembly of Alarm Annunciators and assistance during installation and commissioning.

Retrofitting work by replacing old annunciation system with latest design and for expansion in power stations, substations, process plants as also standard Annunciation Panels for plants and equipments can be catered to.

The Minilec Panel Advantages

- Complete in-house design, assembly of Annunciator Panels.
- Software capability for automation to meet project specifications.
- Component layout as per standards & safety requirements.
- Powder coated MS or Aluminum Rack Panels with quality panel wiring.

