

Für Luft, Wasser, Öl, Dampf etc. einsetzbar.

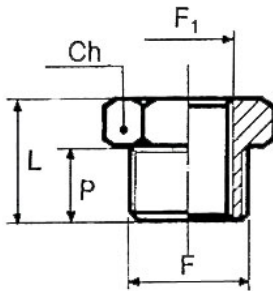

251.02/N

## Reduziernippel

Artikel Nr.	Typen Nr.	Außengewinde F	Innengewinde F1	Ch mm	P mm	L mm
111330	251.00/N	G 1/8	M5	14	6,0	10,5
111331	251.01/N	G 1/4	G 1/8	17	8,0	13,0
111331 = Auslaufartikel. Artikel nicht mehr verfügbar. Ersatzartikel 134710 (MSN251K1418)						
111332	251.06/N	G 3/8	G 1/8	20	9,0	14,0
101040	251.02/N	G 3/8	G 1/4	20	9,0	14,0
111333	251.08/N	G 1/2	G 1/8	24	10,0	15,5
111333 = Auslaufartikel. Artikel nicht mehr verfügbar. Ersatzartikel 134713 (MSN251K1218)						
111334	251.07/N	G 1/2	G 1/4	25	10,0	15,5
111334 = Auslaufartikel. Artikel nicht mehr verfügbar. Ersatzartikel 134714 (MSN251K1214)						
111335	251.03/N	G 1/2	G 3/8	25	10,0	15,5
111335 = Auslaufartikel. Artikel nicht mehr verfügbar. Ersatzartikel 134715 (MSN251K1238)						
111336	251.09/N	G 3/4	G 3/8	30	11,0	17,5
111337	251.10/N	G 3/4	G 1/2	30	11,0	17,5
111337 = Auslaufartikel. Artikel nicht mehr verfügbar. Ersatzartikel 134718 (MSN251K3412)						
111338	251.11/N	G 1	G 1/2	36	12,0	19,0
111339	251.12/N	G 1	G 3/4	36	11,5	19,0

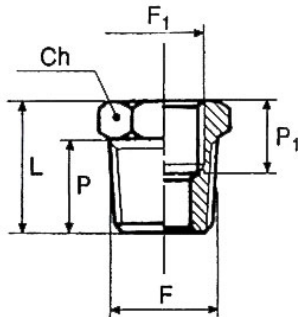

235.04/N

**Reduziernippel, Außengewinde konisch, Innengewinde zylindrisch**

Artikel Nr.	Typen Nr.	Außengewinde F	Innengewinde F1	Ch mm	P mm	P1 mm	L mm
111340	235.01/N	R 1/4	G 1/8	14	11,0	7,0	16,0
111341	235.02/N	R 3/8	G 1/8	17	11,5	7,0	17,0
111342	235.03/N	R 3/8	G 1/4	17	11,5	8,0	17,0
111343	235.04/N	R 1/2	G 1/8	22	14,0	8,0	19,5
111344	235.05/N	R 1/2	G 1/4	22	14,0	8,0	20,0
111345	235.06/N	R 1/2	G 3/8	22	14,0	10,0	20,0
111346	235.07/N	R 3/4	G 3/8	27	16,5	11,5	23,0
111347	235.08/N	R 3/4	G 1/2	27	16,5	14,0	23,0
111348	235.09/N	R 1	G 1/2	34	16,0	15,0	25,0
111349	235.10/N	R 1	G 3/4	34	18,0	15,0	25,0

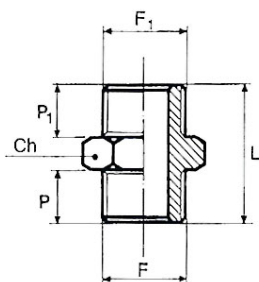

252.62

## Doppelgewindenippel, Außengewinde zylindrisch

Artikel Nr.	Typen Nr.	Gewinde 1 F	Gewinde 2 F1	Ch mm	P mm	P1 mm	L mm
111350	252.31	M5	M5	8	4,0	4,0	11,5
111351	252.32	M5	G 1/8	14	4,0	6,0	14,5
111352	252.33	G 1/8	G 1/8	14	6,0	6,0	17,0
111353	252.34	G 1/8	G 1/4	17	6,0	8,0	19,0
111354	252.35	G 1/8	G 3/8	20	6,0	9,0	20,0
111354 = Auslaufartikel. Artikel nicht mehr verfügbar. Ersatzartikel 131893 (MSN2521838)							
100770	252.61	G 1/4	G 1/4	17	8,0	8,0	21,0
111355	252.62	G 1/4	G 3/8	20	8,0	9,0	22,0
111356	252.63	G 1/4	G 1/2	25	8,0	10,0	24,0
100834	252.64	G 3/8	G 3/8	20	9,0	9,0	24,0
100834 = Auslaufartikel. Artikel nicht mehr verfügbar. Ersatzartikel 131897 (MSN2523838)							
111357	252.65	G 3/8	G 1/2	25	9,0	10,0	25,5
111357 = Auslaufartikel. Artikel nicht mehr verfügbar. Ersatzartikel 131898 (MSN2523812)							
111358	252.65-1	G 3/8	G 3/4	27	9,0	12,0	27,0
100838	252.66	G 1/2	G 1/2	25	10,0	10,0	26,5
100838 = Auslaufartikel. Artikel nicht mehr verfügbar. Ersatzartikel 131900 (MSN2521212)							
111359	252.67	G 1/2	G 3/4	30	10,0	11,0	27,5
111360	252.67-1	G 1/2	G 1	34	10,5	15,0	32,5
111361	252.68	G 3/4	G 1	36	12,0	11,0	30,0
111362	252.69	G 3/4	G 3/4	30	11,0	11,0	28,0
111363	252.70	G 1	G 1	36	12,0	12,0	31,0
111364	252.71	G 1	G 1 1/4	43	15,0	16,0	38,0
111365	252.71-1	G 1	G 1 1/2	50	15,0	16,0	38,5
111366	252.71-2	G 1	G 2	60	15,0	18,0	42,0
111367	252.72	G 1 1/4	G 1 1/4	42	16,0	16,0	39,0
111368	252.72-1	G 1 1/4	G 1 1/2	50	16,0	16,0	40,0
111369	252.72-2	G 1 1/4	G 2	60	16,0	18,0	43,0
111370	252.73	G 1 1/2	G 1 1/2	50	16,0	16,0	39,5
111371	252.73-1	G 1 1/2	G 2	60	17,5	18,0	44,5
111372	252.74	G 2	G 2	60	17,5	17,5	44,0
111373	252.74-1	G 2	G 2 1/2	77	19,0	24,0	54,0
111374	252.74-2	G 2	G 3	89	20,0	20,0	50,0
111375	252.74-3	G 2 1/2	G 2 1/2	77	24,0	24,0	59,0
111376	252.74-4	G 2 1/2	G 3	89	22,5	20,0	52,5
111377	252.74-5	G 3	G 3	89	24,5	24,5	60,0

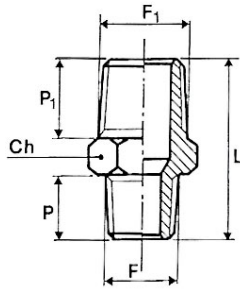

1252.66

**Doppelgewindenippel, Außengewinde konisch**

Artikel Nr.	Typen Nr.	Gewinde 1 F	Gewinde 2 F1	Ch mm	P mm	P1 mm	L mm
111378	1252.33	R 1/8	R 1/8	12	8,0	8,0	21,0
111379	1252.34	R 1/8	R 1/4	14	8,0	11,0	24,0
111380	1252.35	R 1/8	R 3/8	17	8,0	11,5	25,0
111380 = Auslaufartikel. Artikel nicht mehr verfügbar. Ersatzartikel 134784 (MSN252R1838)							
111381	1252.61	R 1/4	R 1/4	14	11,0	11,0	27,0
111382	1252.62	R 1/4	R 3/8	17	11,0	11,5	28,0
111382 = Auslaufartikel. Artikel nicht mehr verfügbar. Ersatzartikel 134786 (MSN252R1438)							
111383	1252.63	R 1/4	R 1/2	22	11,0	14,0	32,0
111384	1252.64	R 3/8	R 3/8	17	11,5	11,5	29,0
111384 = Auslaufartikel. Artikel nicht mehr verfügbar. Ersatzartikel 134788 (MSN252R3838)							
111385	1252.65	R 3/8	R 1/2	22	11,5	14,0	32,5
111386	1252.66	R 1/2	R 1/2	22	14,0	14,0	35,0
111386 = Auslaufartikel. Artikel nicht mehr verfügbar. Ersatzartikel 134792 (MSN252R1212)							
111387	1252.67	R 1/2	R 3/4	27	14,0	16,5	37,0
111388	1252.69	R 3/4	R 3/4	27	16,5	16,5	40,0
111389	1252.68	R 3/4	R 1	34	16,5	19,0	42,5
111390	1252.70	R 1	R 1	34	19,0	19,0	45,5
111390 = Auslaufartikel. Artikel nicht mehr verfügbar. Ersatzartikel 134797 (MSN252R11)							

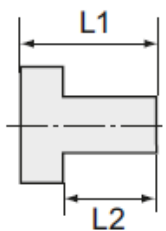

252.92-N

**Verschlusschraube mit Innensechskant und Bund**

Artikel Nr.	Typen Nr.	Gewinde	L1 mm	L2 mm	SW mm
111391	252.91-N	G 1/8	11,0	8,0	5
111392	252.92-N	G 1/4	13,0	10,0	6
111393	252.93-N	G 3/8	15,0	12,0	8
111394	252.94-N	G 1/2	18,0	14,0	10
111395	252.94-2N	G 3/4	24,0	20,0	12
111396	252.94-3N	G1	27,0	22,0	17

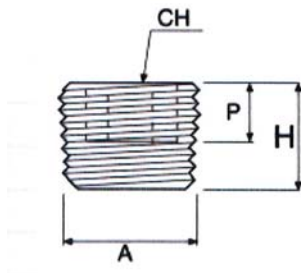

253.102-N

## Verschlusschraube mit Innensechskant, ohne Bund

Artikel Nr.	Typen Nr.	Gewinde A	H mm	P mm	Ch mm
111397	253.101-N	R 1/8	8,0	4,0	5
111398	253.102-N	R 1/4	10,0	5,0	6
111399	253.103-N	R 3/8	10,0	6,0	8
111400	253.104-N	R 1/2	12,0	8,0	10

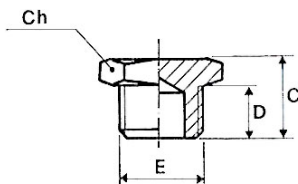

252.96/N

## Verschlusschraube mit Außensechskant

Artikel Nr.	Typen Nr.	Gewinde E	C mm	D mm	Ch mm
111401	252.90/N	M5	7,0	4,0	8
111402	252.95/N	G 1/8	10,0	6,0	14
111403	252.96/N	G 1/4	12,5	8,0	17
111404	252.97/N	G 3/8	13,5	9,0	19
111405	252.98/N	G 1/2	15,5	10,0	24
111406	252.99/N	G 3/4	16,5	11,0	30
111407	252.100/N	G 1	19,0	13,0	38

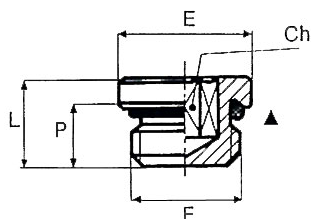

233.05-N

**Verschlussschraube** mit Innensechskant, mit O-Ring

Artikel Nr.	Typen Nr.	Gewinde F	Innen-Sechskant Ch mm	P mm	L mm	E mm	O-Ring mm	Max. Anzugsdrehmomente Nm
111408	233.01-N	M5	2,5	4,0	6,5	8,0	3,5x1,2	1,2
111409	233.02-N	G 1/8	3	7,0	9,5	15,0	7,66x1,78	2,5
111410	233.03-N	G 1/4	6	8,0	11,0	18,0	10,82x1,78	8
111411	233.04-N	G 3/8	8	9,0	12,5	21,0	14,00x1,78	10
111412	233.05-N	G 1/2	10	11,0	14,5	26,0	17,13x2,62	15
111413	233.06-N	G 3/4	17	15,5	20,0	34,0	-	-
111414	233.07-N	G 1	19	16,0	21,0	38,0	-	-

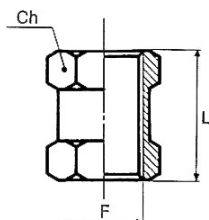

252.23/N

**Muffe** mit Außensechskant

Artikel Nr.	Typen Nr.	Gewinde F	Ch mm	L mm
111415	252.20/N	M5	8	11,0
111416	252.21/N	G 1/8	14	15,0
111417	252.22/N	G 1/4	17	22,0
111418	252.23/N	G 3/8	22	24,0
111419	252.24/N	G 1/2	27	30,0
111420	252.24/1-N	G 3/4	32	32,0
111421	252.25/N	G 1	38	35,0

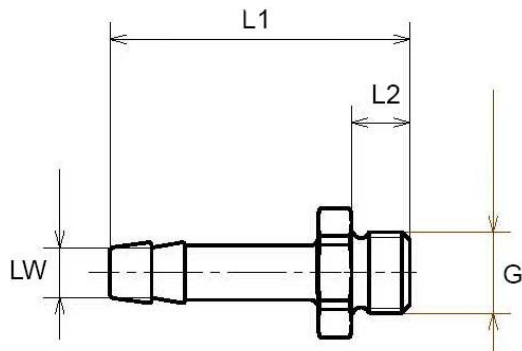

N239 E-N1

## Einschraubschlauchtülle, Außengewinde zylindrisch

Artikel Nr.	Typen Nr.	Gewinde G	für Schlauch mm	L1 mm	L2 mm	SW mm
111422	N239.02-N	G 1/8	LW 6	36,0	7,0	14
111422 = Auslaufartikel. Artikel nicht mehr verfügbar. Ersatzartikel 131040 (MSN2391806)						
111423	N239.02-N1	G 1/8	LW 8	36,0	7,0	14
111424	N239.03-N	G 1/8	LW 9	36,0	7,0	14
111425	N239 A-N	G 1/4	LW 4	36,0	9,0	17
111426	N239 B-N	G 1/4	LW 6	39,0	9,0	17
111427	N239 B-N1	G 1/4	LW 8	39,0	9,0	17
111428	N239 C-N	G 1/4	LW 9	39,0	9,0	17
111429	N239 C-N1	G 1/4	LW 10	39,0	9,0	17
111430	N239 CS-N	G 1/4	LW 13	42,0	9,0	17
111431	N239 E-N1	G 3/8	LW 8	39,0	9,0	19
111432	N239 F-N	G 3/8	LW 9	39,0	9,0	19
111433	N239 F-N1	G 3/8	LW 10	39,0	9,0	19
111434	N239 FS-N	G 3/8	LW 13	42,0	9,0	19
111435	N239 G-N1	G 1/2	LW 8	42,0	11,0	24
111436	N239 H-N	G 1/2	LW 9	42,0	11,0	24
111437	N239 H-N1	G 1/2	LW 10	42,0	11,0	24
111438	N239 J-N	G 1/2	LW 13	45,0	11,0	24
111438 = Auslaufartikel. Artikel nicht mehr verfügbar. Ersatzartikel 131061 (MSN2391213)						
111439	N239 J-N1	G 1/2	LW 16	53,0	11,0	24
111440	N239 J-N2	G 1/2	LW 19	53,0	11,0	24
111441	N239 M-N	G 3/4	LW 13	51,0	12,0	32
111442	N239 N-N	G 3/4	LW 16	51,0	12,0	32
111443	N239 P-N	G 3/4	LW 19	54,0	12,0	32
111444	N239 R-N	G 3/4	LW 25	54,0	12,0	32
111445	N239 W-N	G 1	LW 25	49,0	15,0	34
111446	N239 Z-N	G 1	LW 32	55,0	13,0	38

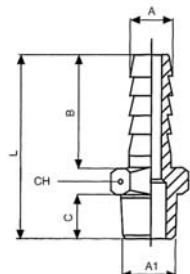

239.107

## Einschraubschlauchtüllen, Außengewinde konisch

Artikel Nr.	Typen Nr.	A mm	Gewinde A1	B mm	C mm	L mm	CH mm
111447	239.101	LW 6	R 1/8	19,0	8,0	31,5	12
111448	239.102	LW 8	R 1/8	19,0	8,0	31,5	12
111448 = Auslaufartikel. Artikel nicht mehr verfügbar. Ersatzartikel 134186 (MSN239R1808)							
111449	239.103	LW 9	R 1/8	19,0	8,0	31,5	12
111449 = Auslaufartikel. Artikel nicht mehr verfügbar. Ersatzartikel 134187 (MSN239R1809)							
111450	239.104	LW 10	R 1/8	20,0	8,0	32,5	12
111451	239.105	LW 6	R 1/4	19,0	11,0	35,0	14
111451 = Auslaufartikel. Artikel nicht mehr verfügbar. Ersatzartikel 134190 (MSN239R1406)							
111452	239.106	LW 8	R 1/4	19,0	11,0	35,0	14
111452 = Auslaufartikel. Artikel nicht mehr verfügbar. Ersatzartikel 134191 (MSN239R1408)							
111453	239.107	LW 9	R 1/4	19,0	11,0	35,0	14
111453 = Auslaufartikel. Artikel nicht mehr verfügbar. Ersatzartikel 134192 (MSN239R1409)							
111454	239.108	LW 10	R 1/4	20,0	11,0	36,0	14
111454 = Auslaufartikel. Artikel nicht mehr verfügbar. Ersatzartikel 134193 (MSN239R1410)							
111455	239.109	LW 12	R 1/4	20,0	11,0	36,0	14
111455 = Auslaufartikel. Artikel nicht mehr verfügbar. Ersatzartikel 134194 (MSN239R1412)							
111456	N239.109-1	LW 13	R 1/4	-	11,5	39,5	14
111457	239.110	LW 9	R 3/8	19,0	11,5	35,5	17
111457 = Auslaufartikel. Artikel nicht mehr verfügbar. Ersatzartikel 134199 (MSN239R3809)							
111458	239.111	LW 10	R 3/8	20,0	11,5	36,5	17
111458 = Auslaufartikel. Artikel nicht mehr verfügbar. Ersatzartikel 134200 (MSN239R3810)							
111459	239.112	LW 12	R 3/8	20,0	11,5	36,5	17
111459 = Auslaufartikel. Artikel nicht mehr verfügbar. Ersatzartikel 134201 (MSN239R3812)							
111460	N239.112-1	LW 13	R 3/8	-	13,0	41,0	17
111461	239.113	LW 9	R 1/2	19,0	14,0	38,5	22
111461 = Auslaufartikel. Artikel nicht mehr verfügbar. Ersatzartikel 134205 (MSN239R1209)							
111462	239.114	LW 10	R 1/2	20,0	14,0	39,5	22
111462 = Auslaufartikel. Artikel nicht mehr verfügbar. Ersatzartikel 134206 (MSN239R1210)							
111463	239.115	LW 12	R 1/2	20,0	14,0	39,5	22
111463 = Auslaufartikel. Artikel nicht mehr verfügbar. Ersatzartikel 134207 (MSN239R1212)							
111464	N239.116	LW 13	R 1/2	-	15,5	44,5	22
111465	N239.117	LW 16	R 1/2	-	15,5	44,5	22
111466	N239.118	LW 19	R 1/2	-	15,5	44,5	22



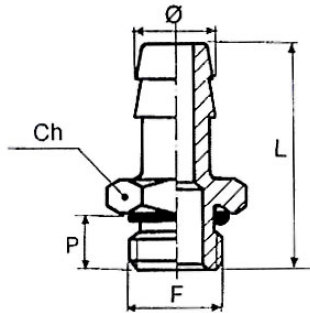

239.515

## Einschraubschlauchtülle, zylindrisch, mit O-Ring

Artikel Nr.	Typen Nr.	für Schlauch Ø mm	Gewinde F	Ch mm	P mm	L mm	O-Ring mm
111467	239.501	LW 6	G 1/8	14	6,5	30,0	7,66x1,78
111468	239.502	LW 8	G 1/8	15	6,0	31,0	7,66x1,78
111469	239.503	LW 9	G 1/8	15	6,0	31,0	7,66x1,78
111470	239.505	LW 6	G 1/4	17	8,0	32,0	10,82x1,78
111471	N239.506-N	LW 8	G 1/4	17	8,0	32,0	-
111472	239.507	LW 9	G 1/4	18	8,0	33,0	10,82x1,78
111473	N239.508-N	LW 10	G 1/4	17	8,0	33,0	-
111474	239.509	LW 12	G 1/4	18	8,0	33,0	10,82x1,78
111475	N239.520-N	LW 13	G 1/4	18	8,0	33,0	-
111476	N239.521-N	LW 6	G 3/8	20	9,0	33,0	-
111477	N239.522-N	LW 8	G 3/8	20	9,0	33,0	-
111478	239.510	LW 9	G 3/8	21	9,0	34,0	14,00x1,78
111479	N239.511-N	LW 10	G 3/8	20	9,0	34,0	-
111480	239.512	LW 12	G 3/8	21	9,0	34,0	14,00x1,78
111481	N239.513-N	LW 13	G 3/8	21	9,0	34,0	-
111482	239.515	LW 12	G 1/2	26	11,0	36,0	17,13x2,62
111483	N239.516-N	LW 13	G 1/2	24	10,0	36,0	-
111484	N239.517-N	LW 16	G 1/2	25	10,0	40,0	-
111485	N239.518-N	LW 19	G 1/2	24	10,0	40,0	-

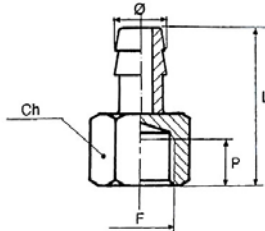

237.09-N

**Aufschraubschlauchtülle** mit Innengewinde zylindrisch

Artikel Nr.	Typen Nr.	Für Schlauch Ø mm	Gewinde F	Ch mm	P mm	L mm
111486	237.01-N	LW 6	G 1/8	12	8,5	28,0
111487	237.02-N	LW 8	G 1/8	12	8,5	28,0
111488	237.03-N	LW 9	G 1/8	12	8,5	28,0
111489	237.04-N	LW 10	G 1/8	12	8,5	28,0
111490	237.05-N	LW 6	G 1/4	15	10,0	33,0
111491	237.06-N	LW 8	G 1/4	15	10,0	33,0
111491 = Auslaufartikel. Artikel nicht mehr verfügbar. Ersatzartikel 134883 (MSN239A1408)						
111492	237.07-N	LW 9	G 1/4	15	10,0	33,0
111493	237.08-N	LW 10	G 1/4	15	10,0	33,0
111493 = Auslaufartikel. Artikel nicht mehr verfügbar. Ersatzartikel 134885 (MSN239A1410)						
111494	237.09-N	LW 12	G 1/4	15	10,0	33,0
111495	237.10-N	LW 8	G 3/8	19	12,0	35,0
111496	237.11-N	LW 10	G 3/8	19	12,0	35,0
111497	237.12-N	LW 12	G 3/8	19	12,0	35,0
111498	237.13-N	LW 14	G 3/8	19	12,0	35,0
111499	237.14-N	LW 10	G 1/2	25	14,0	38,0
111500	237.15-N	LW 12	G 1/2	25	14,0	41,0
111500 = Auslaufartikel. Artikel nicht mehr verfügbar. Ersatzartikel 134900 (MSN239A1212)						
111501	237.16-N	LW 14	G 1/2	25	14,0	41,0

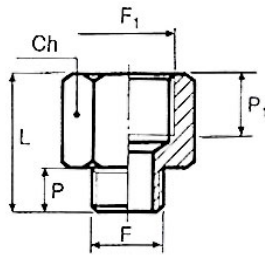

230.08-N

### Verlängerungsstück, kurz, zylindrisch

Artikel Nr.	Typen Nr.	Außen- gewinde F	Innen- gewinde F1	Ch mm	P mm	P1 mm	L mm
111502	230.01-N	M5	G 1/8	12	4,0	7,0	17,0
111503	230.02-N	G 1/8	G 1/8	14	6,0	7,0	18,5
111504	230.03-N	G 1/8	G 1/4	17	6,0	8,0	21,5
111505	230.04-N	G 1/4	G 1/4	17	8,0	8,0	22,5
111506	230.05-N	G 1/4	G 3/8	22	8,0	10,0	26,0
111507	230.06-N	G 3/8	G 3/8	22	9,0	10,0	26,5
111508	230.07-N	G 3/8	G 1/2	24	9,0	11,0	29,5
111509	230.08-N	G 1/2	G 1/2	25	10,0	11,0	29,5

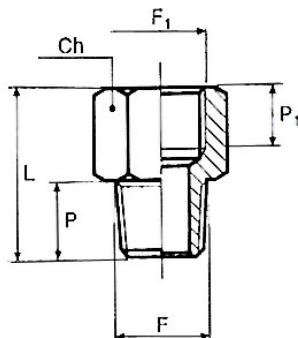

1230.10-N

### Verlängerungsstück, kurz, Außengewinde konisch, Innengewinde zylindrisch

Artikel Nr.	Typen Nr.	Außen- gewinde F	Innen- gewinde F1	Ch mm	P mm	P1 mm	L mm
111510	1230.02-N	R 1/8	G 1/8	14	8,0	7,0	20,0
111511	1230.03-N	R 1/8	G 1/4	17	8,0	8,0	22,5
111512	1230.09-N	R 1/8	G 3/8	22	8,0	11,5	21,5
111513	1230.04-N	R 1/4	G 1/4	17	11,0	8,0	25,0
111514	1230.05-N	R 1/4	G 3/8	22	11,0	10,0	28,5
111515	1230.06-N	R 1/4	G 1/2	24	11,0	14,0	29,0
111516	1230.07-N	R 3/8	G 3/8	22	11,5	10,0	28,5
111517	1230.08-N	R 3/8	G 1/2	24	11,5	11,0	32,0
111518	1230.10-N	R 1/2	G 1/2	24	14,0	11,0	34,0
111519	1230.11-N	R 1/2	G 3/4	32	14,0	16,5	35,0

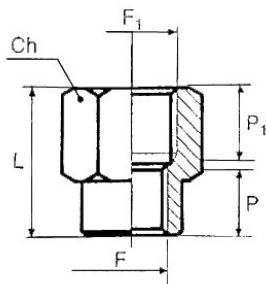

231.07-N

Verlängerungsstück, 2 x Innengewinde, zylindrisch

Artikel Nr.	Typen Nr.	Gewinde F	Gewinde F1	Ch mm	P mm	P1 mm	L mm
111520	231.01-N	M5	G 1/8	14	5,0	8,0	13,5
111521	231.02-N	G 1/8	G 1/4	17	8,0	8,0	21,5
111522	231.03-N	G 1/8	G 3/8	22	7,0	10,0	23,5
111523	231.04-N	G 1/4	G 3/8	22	9,0	10,0	25,5
111524	231.05-N	G 1/4	G 1/2	24	9,0	11,0	28,5
111525	231.06-N	G 3/8	G 1/2	24	11,0	11,0	29,5
111526	231.07-N	G 1/2	G 3/4	32	11,5	16,5	30,0
111527	231.08-N	G 1/2	G 1/8	24	-	-	24,0
111528	231.09-N	G 1	G 3/4	38	-	-	25,0

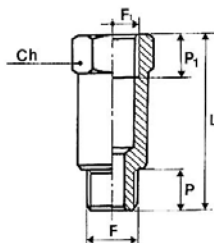

234.07-N

Verlängerungsstück, lang, zylindrisch

Artikel Nr.	Typen Nr.	Außen-gewinde F	Innen-gewinde F1	Ch mm	P mm	L mm	P1 mm
111529	234.01-N	G 1/8	G 1/8	14	6,0	22,0	8,0
111530	234.02-N	G 1/8	G 1/8	14	6,0	42,0	8,0
111531	234.03-N	G 1/8	G 1/8	14	6,0	51,0	6,0
111532	234.04-N	G 1/8	G 1/8	14	6,0	100,0	8,0
111533	234.05-N	G 1/4	G 1/4	17	8,0	35,0	11,0
111534	234.06-N	G 1/4	G 1/4	17	8,0	51,0	11,0
111535	234.07-N	G 1/4	G 1/4	17	8,0	100,0	11,0

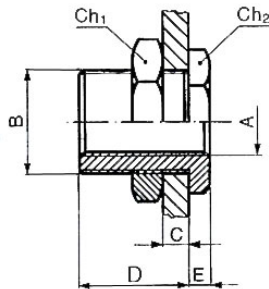

232.04-N

## Schottverschraubung

Artikel Nr.	Typen Nr.	Innen- gewinde A	Außen- gewinde B	Betriebs- temperatur max. °C	D mm	E mm	Ch1 mm	Ch2 mm
111536	232.01-N	G 1/8	M16x1,5	150	14,0	4,0	19	22
111537	232.02-N	G 1/4	M20x1,5	150	21,0	5,0	27	24
111538	232.03-N	G 3/8	M26x1,5	150	21,0	5,0	30	32
111539	232.04-N	G 1/2	M28x1,5	150	27,0	6,5	36	32
111539 = Auslaufartikel. Artikel nicht mehr verfügbar. Ersatzartikel 138495 (MSN232M2812)								

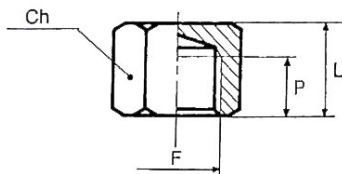

236.04-N

## Verschlusskappe

Artikel Nr.	Typen Nr.	Gewinde F	Ch mm	P mm	L mm
111540	236.01-N	G 1/8	14	7,0	13,0
111541	236.02-N	G 1/4	17	8,0	15,0
111542	236.03-N	G 3/8	20	10,0	17,5
111543	236.04-N	G 1/2	24	11,0	20,0
111544	236.05-N	G 3/4	30	-	14,0
111545	236.06-N	G 1	37	-	15,0

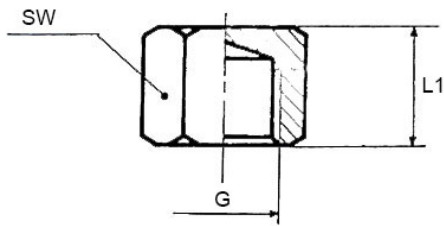

239.03-N

**Sechskant-Überwurfmutter**

Artikel Nr.	Typen Nr.	Gewinde	für Tüllengröße	L1 mm	SW mm
111546	239.01-N	G 1/8	LW 4, LW 6	13,0	14
111547	239.02-N	G 1/4	LW 4, LW 6	15,0	17
111548	239.03-N	G 3/8	LW 9	15,0	19
111549	239.04-N	G 1/2	LW 4, LW 6, LW9	16,0	24

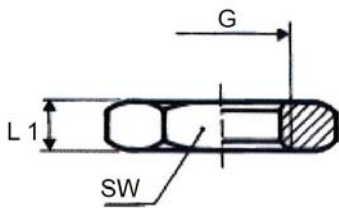

238.03-N

**Sechskant-Gegenmutter**

Artikel Nr.	Typen Nr.	Gewinde	L1 mm	SW mm
111550	238.01-N	G 1/8	4,5	14
111550 = Auslaufartikel. Artikel nicht mehr verfügbar. Ersatzartikel 138502 (MSN23818)				
111551	238.02-N	G 1/4	5,0	17
111552	238.03-N	G 3/8	5,5	19
111552 = Auslaufartikel. Artikel nicht mehr verfügbar. Ersatzartikel 138504 (MSN23838)				
111553	238.04-N	G 1/2	6,0	24
111554	238.05-N	G 3/4	6,0	32
111555	238.06-N	G 1	8,0	38