

Extremely Thin Relays Integrated with Heat Sinks

- Downsizing achieved through optimum design of heat sink.
- Mounting possible via screws or via DIN track.
- Close mounting possible for linking terminals. (Except for G3PA-260B-VD and G3PA-450B-VD-2.)
- Applicable with 3-phase loads.
- Replaceable power element cartridges.
- Comply with VDE 0160 (finger protection), with a dielectric strength of 4,000 V between input and load.
- Certified by UL, CSA, and VDE (reinforced insulation).



Refer to *Safety Precautions for All Solid State Relays*.

Model Number Structure

■ Model Number Legend

G3PA-□□□□-□-□

1 2 3 4 5 6 7

1. Basic Model Name

G3PA: Solid State Relay

2. Rated Load Power Supply Voltage

2: 200 VAC

4: 400 VAC

3. Rated Load Current

10: 10 A

20: 20 A

30: 30 A

40: 40 A

50: 50 A

60: 60 A

4. Terminal Type

B: Screw terminals

5. Zero Cross Function

Blank: Equipped with zero cross function

L: Not equipped with zero cross function

6. Certification

VD: Certified by UL, CSA, and VDE

7. Special Specifications

Blank: Standard models

2: 480-V models

Ordering Information

■ List of Models

Model	Isolation	Zero cross function	Indicator	Rated output load	Rated input voltage	
G3PA-210B-VD	Phototriac coupler	Yes	Yes	10 A at 24 to 240 VAC	5 to 24 VDC	
G3PA-220B-VD				20 A at 24 to 240 VAC		
G3PA-240B-VD				40 A at 24 to 240 VAC		
G3PA-260B-VD				60 A at 24 to 240 VAC		
G3PA-210BL-VD		No		10 A at 24 to 240 VAC		
G3PA-220BL-VD				20 A at 24 to 240 VAC		
G3PA-240BL-VD				40 A at 24 to 240 VAC		
G3PA-260BL-VD				60 A at 24 to 240 VAC		
G3PA-210B-VD		Yes		10 A at 24 to 240 VAC	24 VAC	
G3PA-220B-VD				20 A at 24 to 240 VAC		
G3PA-240B-VD				40 A at 24 to 240 VAC		
G3PA-260B-VD				60 A at 24 to 240 VAC		
G3PA-420B-VD					20 A at 180 to 400 VAC	12 to 24 VDC
G3PA-430B-VD					30 A at 180 to 400 VAC	
G3PA-420B-VD-2					20 A at 200 to 480 VAC	
G3PA-430B-VD-2					30 A at 200 to 480 VAC	
G3PA-450B-VD-2	50 A at 200 to 480 VAC					

Note: When ordering, specify the rated input voltage.

Replacement Parts

Name	Carry current	Load voltage range	Model	Applicable SSR	VDE certification	
Power Device Cartridge	10 A	19 to 264 VAC	G32A-A10-VD DC5-24	G3PA-210B-VD DC5-24	Yes	
			G32A-A10L-VD DC5-24	G3PA-210BL-VD DC5-24		
			G32A-A10-VD AC24	G3PA-210B-VD AC24		
			G32A-A20-VD DC5-24	G3PA-220B-VD DC5-24		
	20 A		G32A-A20L-VD DC5-24	G3PA-220BL-VD DC5-24		
			G32A-A20-VD AC24	G3PA-220B-VD AC24		
			40 A	G32A-A40-VD DC5-24		G3PA-240B-VD DC5-24
				G32A-A40L-VD DC5-24		G3PA-240BL-VD DC5-24
	G32A-A40-VD AC24			G3PA-240B-VD AC24		
	60 A			G32A-A60-VD DC5-24		G3PA-260B-VD DC5-24
			G32A-A60L-VD DC5-24	G3PA-260BL-VD DC5-24		
			G32A-A60-VD AC24	G3PA-260B-VD AC24		
			20 A	150 to 440 VAC		G32A-A420-VD DC12-24
	G32A-A430-VD DC12-24					G3PA-430B-VD DC12-24
	30 A		180 to 528 VAC	G32A-A420-VD-2 DC12-24		G3PA-420B-VD-2 DC12-24
				G32A-A430-VD-2 DC12-24		G3PA-430B-VD-2 DC12-24
50 A	G32A-A450-VD-2 DC12-24	G3PA-450B-VD-2 DC12-24				

■ Other Units (Order Separately)

Units that Enable 2-line Switching of 3-phase Power

Name	Current flow	Model	Applicable SSR
Short-circuit Unit	10 A	G32A-D20	G3PA-210B-VD, G3PA-210BL-VD
	20 A		G3PA-220B-VD, G3PA-220BL-VD G3PA-420B-VD, G3PA-420B-VD-2
	30 A	G32A-D40	G3PA-430B-VD, G3PA-430B-VD-2
	40 A		G3PA-240B-VD, G3PA-240BL-VD

Note: Refer to *List of Certified Models* for a list of products that comply with safety standards.

Specifications

■ Ratings (at an Ambient Temperature of 25°C)

Input

Model	Rated voltage	Operating Voltage range	Input current impedance	Voltage level	
				Must operate voltage	Must release voltage
G3PA-210B-VD	5 to 24 VDC	4 to 30 VDC	7 mA max.	4 VDC max.	1 VDC min.
G3PA-220B-VD					
G3PA-240B-VD					
G3PA-260B-VD					
G3PA-210BL-VD	5 to 24 VDC	4 to 30 VDC	20 mA max.	4 VDC max.	1 VDC min.
G3PA-220BL-VD					
G3PA-240BL-VD					
G3PA-260BL-VD					
G3PA-210B-VD	24 VAC	19.2 to 26.4 VAC	1.4 kΩ±20%	19.2 VAC max.	4.8 VAC min.
G3PA-220B-VD					
G3PA-240B-VD					
G3PA-260B-VD					
G3PA-420B-VD	12 to 24 VDC	9.6 to 30 VDC	7 mA max.	9.2 VDC max.	1 VDC min.
G3PA-430B-VD					
G3PA-420B-VD-2					
G3PA-430B-VD-2					
G3PA-450B-VD-2					

Output

Model	Applicable load			
	Rated load voltage	Load voltage range	Load current	Inrush current
G3PA-210B(L)-VD	24 to 240 VAC (50/60 Hz)	19 to 264 VAC (50/60 Hz)	0.1 to 10 A at 40°C	150 A (60 Hz, 1 cycle)
G3PA-220B(L)-VD			0.1 to 20 A at 40°C	220 A (60 Hz, 1 cycle)
G3PA-240B(L)-VD			0.5 to 40 A at 40°C	440 A (60 Hz, 1 cycle)
G3PA-260B(L)-VD			0.5 to 60 A at 40°C	440 A (60 Hz, 1 cycle)
G3PA-420B-VD	180 to 400 VAC (50/60 Hz)	150 to 440 VAC (50/60 Hz)	0.5 to 20 A at 30°C	220 A (60 Hz, 1 cycle)
G3PA-430B-VD			0.5 to 30 A at 30°C	440 A (60 Hz, 1 cycle)
G3PA-420B-VD-2	200 to 480 VAC (50/60 Hz)	180 to 528 VAC (50/60 Hz)	0.5 to 20 A at 30°C	220 A (60 Hz, 1 cycle)
G3PA-430B-VD-2			0.5 to 30 A at 30°C	440 A (60 Hz, 1 cycle)
G3PA-450B-VD-2			0.5 to 50 A at 30°C	440 A (60 Hz, 1 cycle)

Refer to *Engineering Data* for further details.

■ Characteristics

Item	G3PA-210B(L)-VD	G3PA-220B(L)-VD	G3PA-240B(L)-VD	G3PA-260B(L)-VD	G3PA-420B-VD	G3PA-420B-VD-2	G3PA-430B-VD	G3PA-430B-VD-2	G3PA-450B-VD-2
Operate time	1/2 of load power source cycle + 1 ms max. (DC Input, -B models) 1 1/2 of load power source cycle + 1 ms max. (AC Input) 1 ms max. (-BL models)								
Release time	1/2 of load power source cycle + 1 ms max. (DC Input) 1 1/2 of load power source cycle + 1 ms max. (AC Input)								
Output ON voltage drop	1.6 V (RMS) max.				1.8 V (RMS) max.				
Leakage current	5 mA max. (at 100 VAC) 10 mA max. (at 200 VAC)		10 mA max. (at 100 VAC) 20 mA max. (at 200 VAC)		20 mA max. (at 400 VAC)	20 mA max. (at 480 VAC)	20 mA max. (at 400 VAC)	20 mA max. (at 480 VAC)	
I ² t	260 A ² s		1,260 A ² s		260 A ² s	1,800 A ² s	1,800 A ² s		1,800 A ² s
Insulation resistance	100 MΩ min. (at 500 VDC)								
Dielectric strength	4,000 VAC, 50/60 Hz for 1 min								
Vibration resistance	Destruction: 10 to 55 to 10 Hz, 0.375-mm single amplitude (Mounted to DIN track)								
Shock resistance	Destruction: 300 m/s ² (mounted to DIN track)								
Ambient temperature	Operating: -30°C to 80°C (with no icing or condensation) Storage: -30°C to 100°C (with no icing or condensation)								
Certified standards	UL508, CSA C22.2 (No.14, No.950), EN60950-1 File No. 5915ÜG				UL508, CSA C22.2 (No.14), EN60947-4-3 File No. 6642ÜG	UL508, CSA C22.2 (No.14), EN60947-4-3 File No. 133127ÜG	UL508, CSA C22.2 (No.14), EN60947-4-3 File No. 6642ÜG	UL508, CSA C22.2 (No.14), EN60947-4-3 File No. 133127ÜG	
EMC	Emission: EN55011 Group 1 Class A Immunity: EN61000-6-2								
Ambient humidity	Operating: 45% to 85%								
Weight	Approx. 260 g	Approx. 340 g	Approx. 460 g	Approx. 900 g	Approx. 290 g	Approx. 290 g	Approx. 410 g	Approx. 410 g	Approx. 900 g

Operation

■ Replacement Parts

G32A-A Power Device Cartridge

The G32A-A Power Device Cartridge (a Triac Unit) can be replaced with a new one. When the temperature indicator has changed from pink to red, the triac circuitry may have malfunctioned possibly by an excessive flow of current, in which case, dismount the damaged cartridge for replacement.

The damaged cartridge can be replaced with a new one without disconnecting the wires from the G3PA.

Improve the heat radiation efficiency of the G3PA before replacing the cartridge.

The G32A-A Power Device Cartridge can withstand an excessive current for a short period of time, such as may be caused accidentally by the short circuitry of the load, in which case the temperature indicator will not turn red.

Be sure to turn OFF the power supply when replacing the Cartridge. Supplying power with the Cartridge removed may result in malfunction.

Appearance

G32A-A10(L)-VD

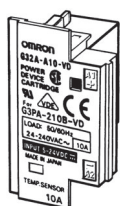

G32A-A20(L)-VD

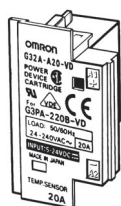

G32A-A40(L)-VD

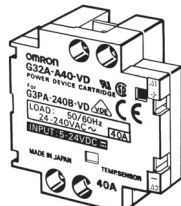

G32A-A60(L)-VD

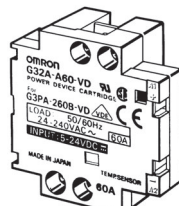

G32A-A420-VD(-2)

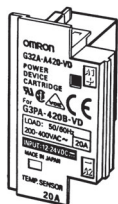

G32A-A430-VD(-2)

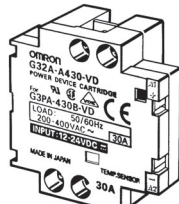

G32A-A450-VD-2

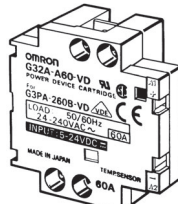

Replacing Power Device Cartridges

When replacing Power Device Cartridges, use the specified model. Using a Power Device Cartridge other than the specified one will result in faulty operation and destruction of the elements.

■ Replacement Procedure

G32A-A10(L)-VD/G32A-A20(L)-VD/G32-A420-VD(-2)

To remove or replace the Power Device Cartridge, use the special tool provided with it for extraction.

Extraction

Follow the procedures below to dismantle the Power Device Cartridge from the G3PA.

1. Switch off the power.
2. Remove the terminal cover.
3. Hook the indented part of the cartridge with the tool and pull up on the cartridge to remove it.

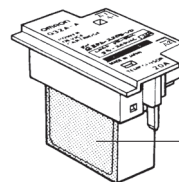
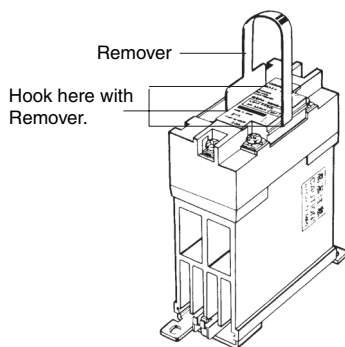

2. Make sure that there is no dust or pieces of wire on the heat sink of the G32A-A or the G3PA.
3. Insert the cartridge into the opening of the G3PA so that the letters on the cartridge and those on the G3PA are in the same direction and side A and side B are even.

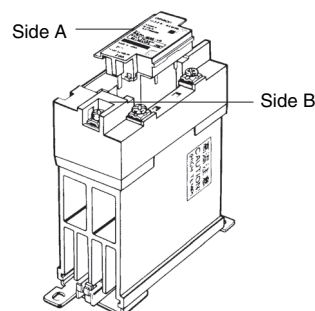

Mounting

Follow the procedures below to mount the Power Device Cartridge on the G3PA.

1. Apply silicone grease (provided with the G32A-A) to the entire surface of the heat sink.

4. Attach the terminal cover.
5. Switch on the power and check the G3PA to be sure it works properly.

G32A-A40(L)-VD/G32A-A60(L)-VD/G32A-A430-VD(-2)/G32A-A450-VD-2

The G32A Power Device Cartridge is mounted and secured with screws to the G3PA Unit.

Extraction

Follow the procedures below to dismantle the G32A-A Power Device Cartridge from the G3PA.

1. Switch off the power.
2. Remove the terminal cover.
3. Loosen the two centered screws on the sides to dismantle the cartridge. The screws are connected to terminals 1 and 2.

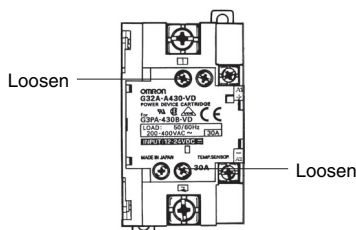

4. Loosen the screws on both the corners.

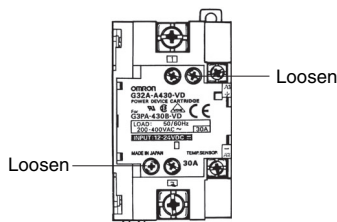

5. Hold the indented part of both the corners to dismantle the cartridge.

Mounting

1. Apply silicone grease to the entire surface of the heat sink.

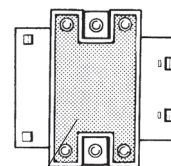

2. Make sure that there is no dust or pieces of wire on the heat sink of the G32A-A or the G3PA.

3. Insert the cartridge into the opening of the G3PA so that side A and side B are even.

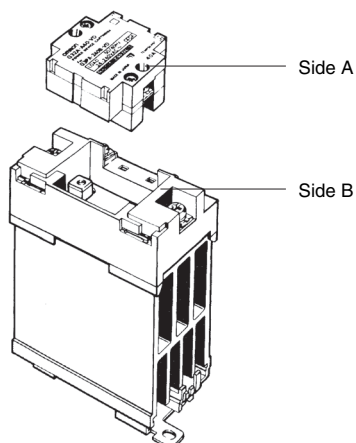

4. Tighten the screws on both the corners with a tightening torque of 0.59 to 0.78 N·m.
5. Tighten the screws on both the sides with a tightening torque of 0.59 to 0.78 N·m.
6. Attach the terminal cover.
7. Switch on the power and check the G3PA to be sure it works properly.

■ Linking Terminal Connection

- Connecting with linking terminal for G3PA-210B(L)-VD, -220B(L)-VD, -240B(L)-VD and G3PA-420B-VD(-2), G3PA-430B-VD(-2).

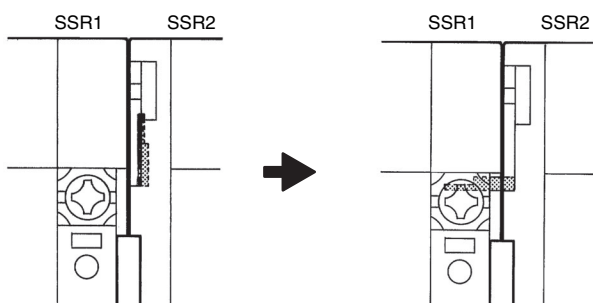

1. When SSRs are close mounted, loosen the M3.5 Sems screw and flip the linking terminal down.

2. Insert the linking terminal securely into the center of the screw and tighten the screw.

- Connecting with linking terminal for G32A.

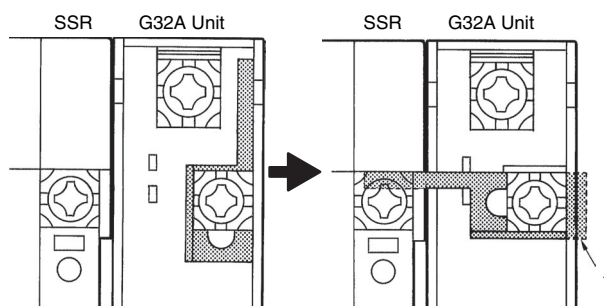

1. When SSR are close mounted, loosen the M3.5 Sems screw on the G32A and flip the linking terminal down.

* The cover will not fit if the terminal protrudes.

2. Insert the linking terminal securely into the center of the screw and tighten the screw. Ensure that the linking terminal does not protrude.

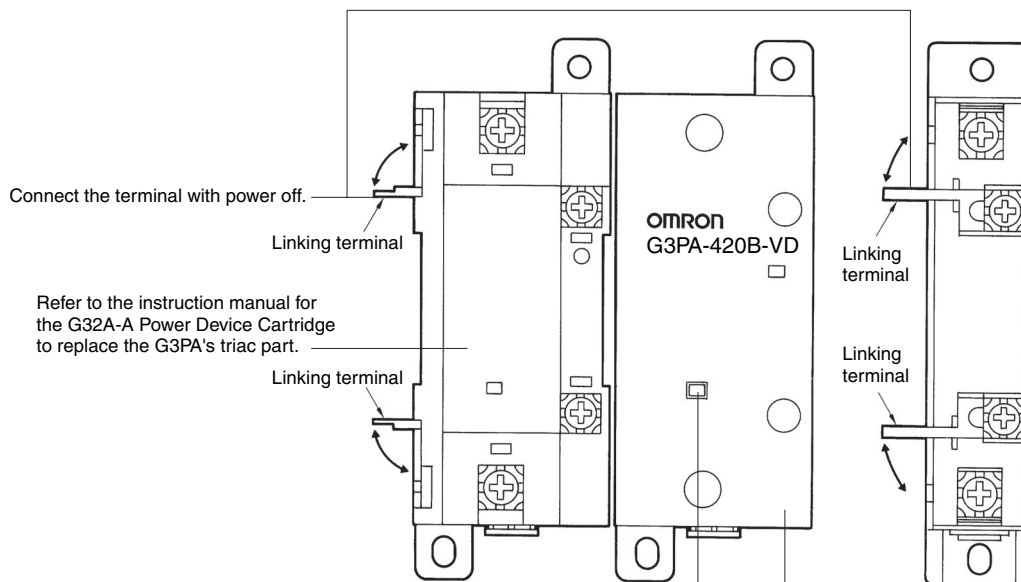

When the temperature indicator has turned from pink to red, the G32A-A Power Device Cartridge may have malfunctioned, in which case the cartridge must be replaced with a new one.

Use the terminal cover to prevent accidents due to electric shock.

Engineering Data

Load Current vs. Ambient Temperature

Vertical Mounting

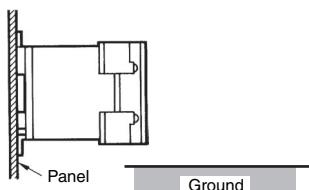

G3PA-210B(L)-VD, G3PA-220B(L)-VD

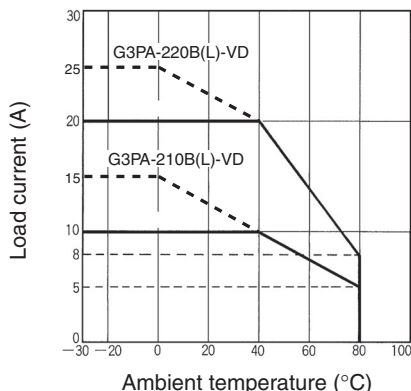

G3PA-240B(L)-VD

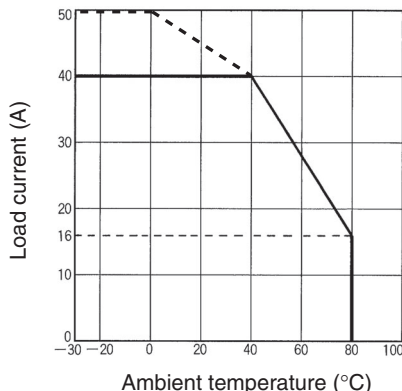

G3PA-260B(L)-VD

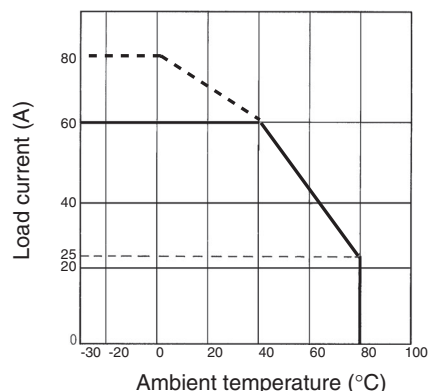

G3PA-220B-VD

For single mounting, the ambient temperature is 80°C. The rated current is 5 A.
 For close mounting of two or three SSRs, limit the load current to 90% or less.

G3PA-420B-VD, G3PA-420B-VD-2

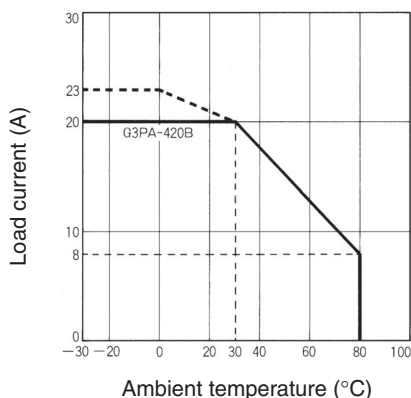

G3PA-430B-VD, G3PA-430B-VD-2

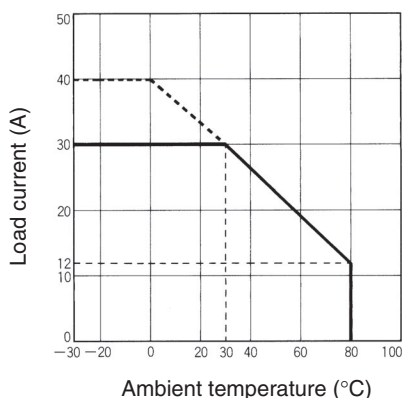

G3PA-450B-VD-2

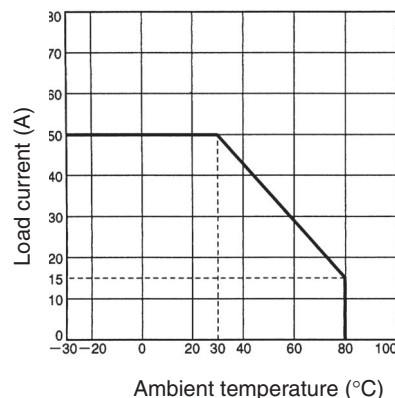

G3PA-420B-VD

For single mounting, the ambient temperature is 80°C. The rated current is 5 A.
 For close mounting of two or three SSRs, limit the load current to 80% or less.

Input Voltage vs. Input Current

G3PA-2□0B-VD

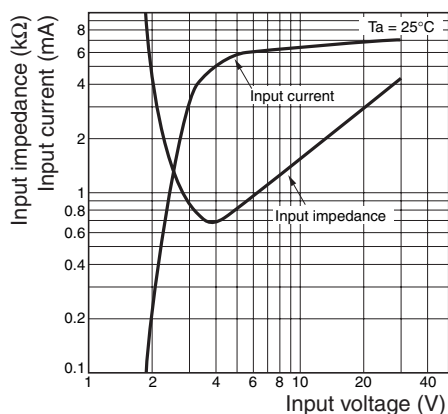

G3PA-4□0-VD, G3PA-4□-VD-2

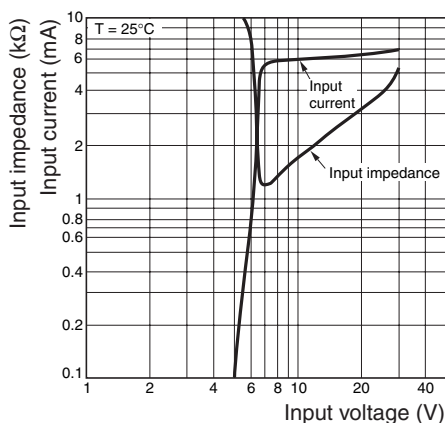

Horizontal Mounting

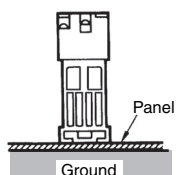

G3PA-210B(L)-VD, G3PA-220B(L)-VD

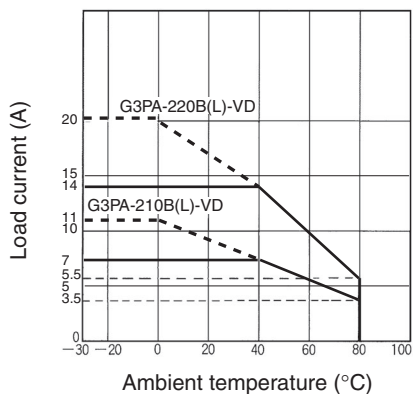

G3PA-240B(L)-VD

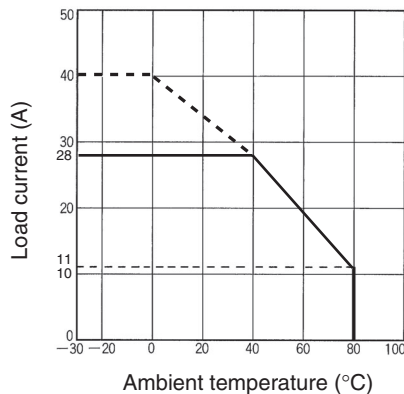

G3PA-260B(L)-VD

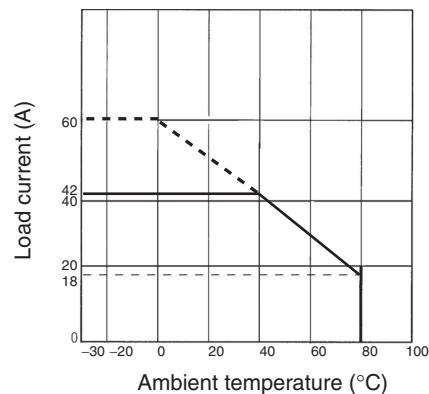

G3PA-420B-VD, G3PA-430B-VD
G3PA-420B-VD-2, G3PA-430B-VD-2

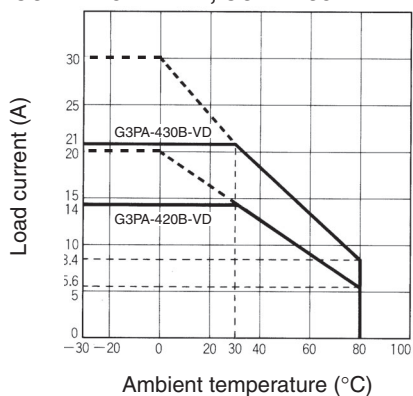

G3PA-450B-VD-2

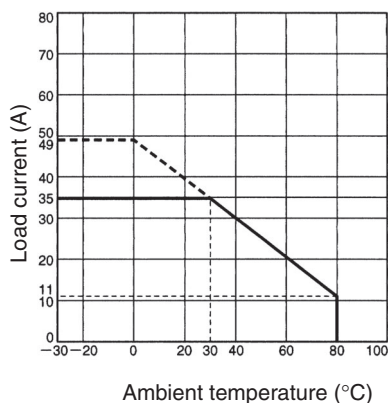

Close Mounting (Up to Three)

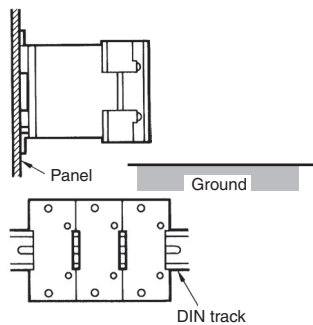

G3PA-210B(L)-VD, G3PA-220B(L)-VD

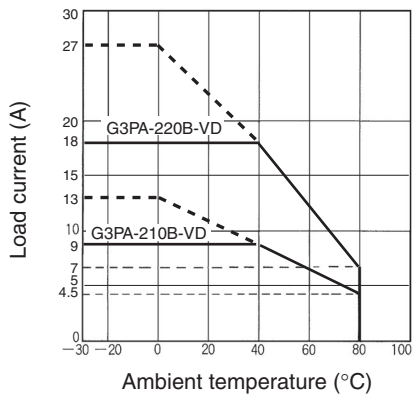

G3PA-240B(L)-VD

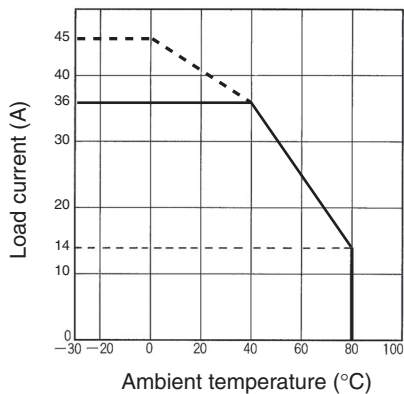

G3PA-260B(L)-VD

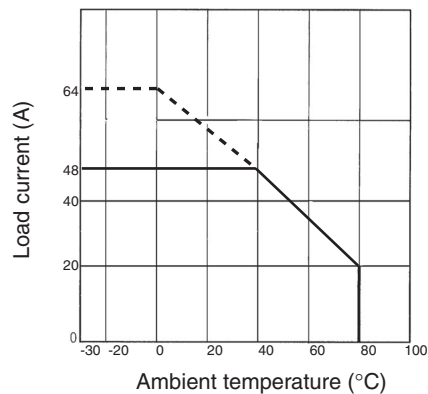

G3PA-420B-VD, G3PA-420B-VD-2

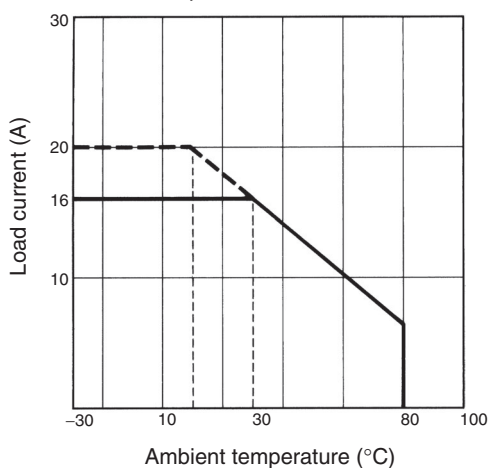

G3PA-430B-VD, G3PA-430B-VD-2

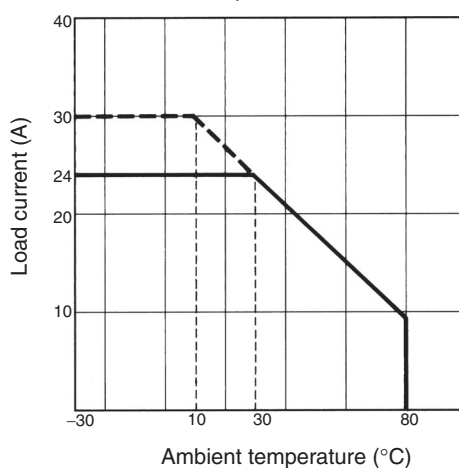

G3PA-450B-VD-2

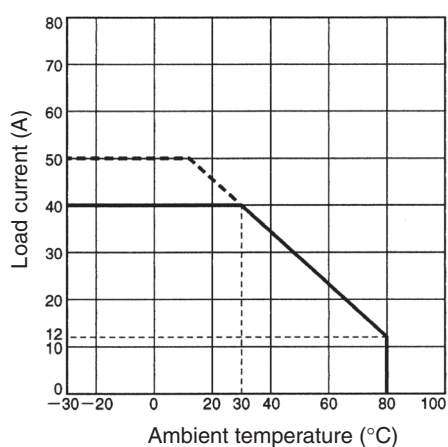

One Cycle Surge Current: Non-repetitive

Note: Keep the inrush current to half the rated value if it occurs repetitively.

G3PA-210B(L)-VD

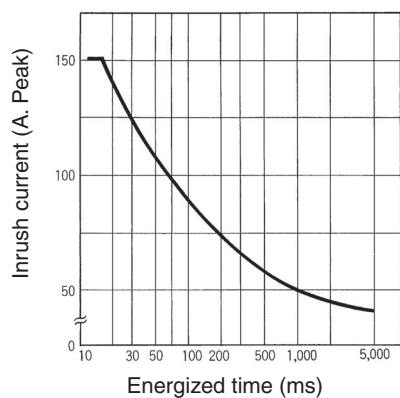

G3PA-220B(L)-VD, G3PA-420B-VD,
G3PA-420B-VD-2

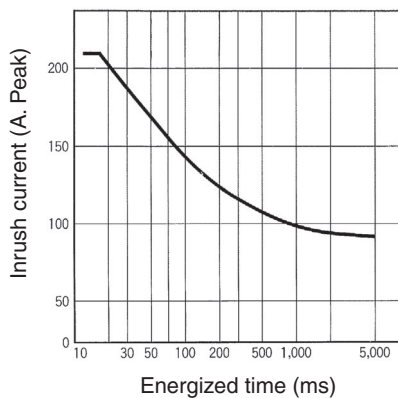

G3PA-240B(L)-VD/260B(L)-VD,
G3PA-430B-VD, G3PA-430B-VD-2,
G3PA-450B-VD-2

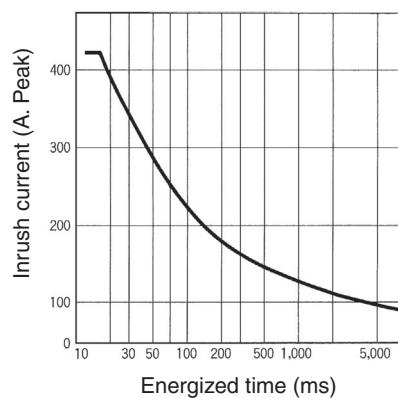

Dimensions

Note: All units are in millimeters unless otherwise indicated.

G3PA-210B(L)-VD

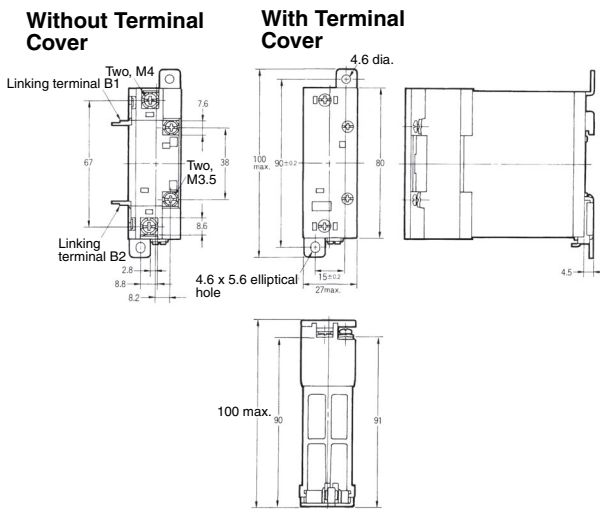
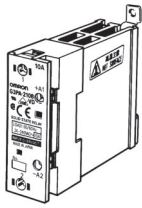

Mounting Holes

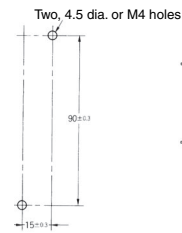

Terminal Arrangement/ Internal Connections

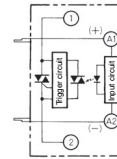

G3PA-220B(L)-VD

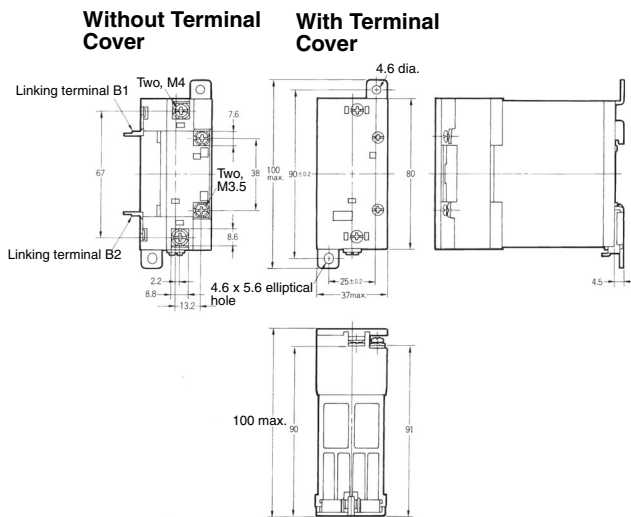
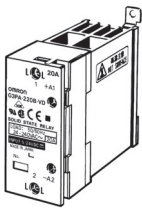

Mounting Holes

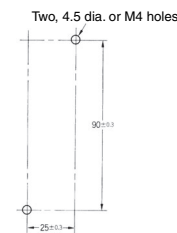

Terminal Arrangement/ Internal Connections

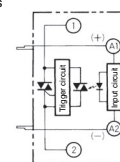

G3PA-240B(L)-VD

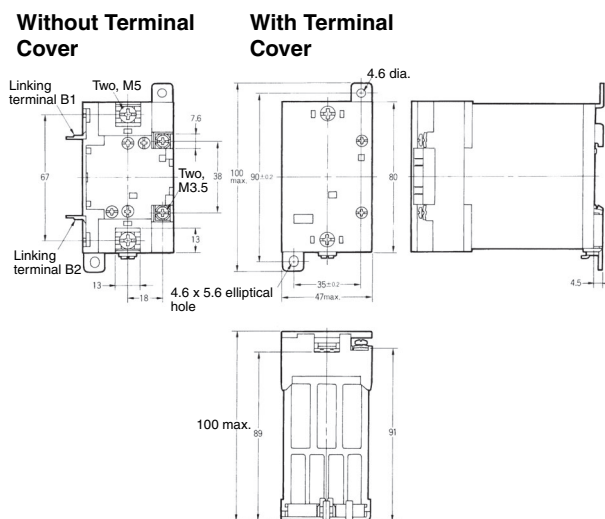
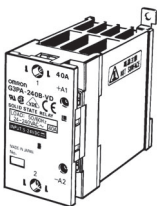

Mounting Holes

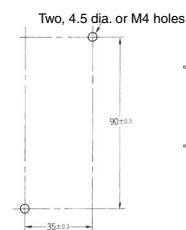

Terminal Arrangement/ Internal Connections

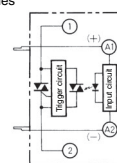

G3PA-260B(L)-VD G3PA-450B-VD-2

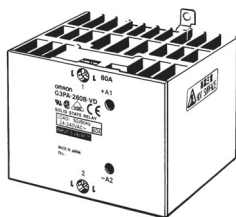

With Terminal Cover

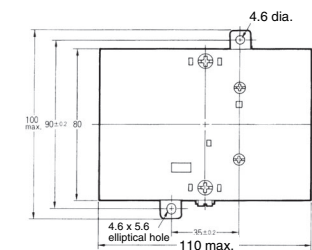

Without Terminal Cover

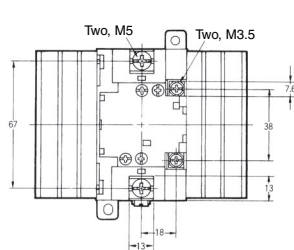

Mounting Holes

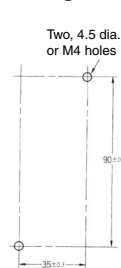

**Terminal Arrangement/
Internal Connections**

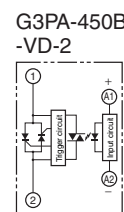
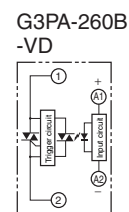

G3PA-420B-VD, G3PA-420B-VD-2

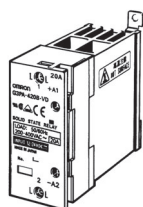

Without Terminal Cover

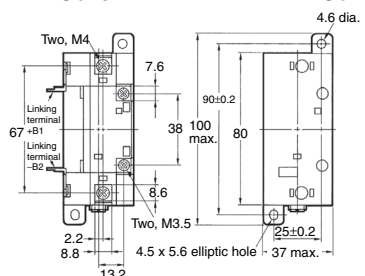

With Terminal Cover

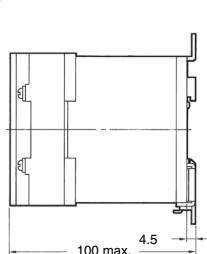

Mounting Holes

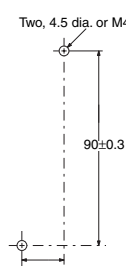

**Terminal Arrangement/
Internal Connections**

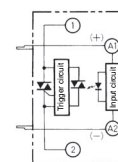

G3PA-430B-VD, G3PA-430B-VD-2

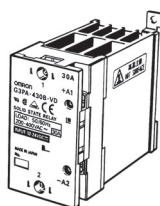

Without Terminal Cover

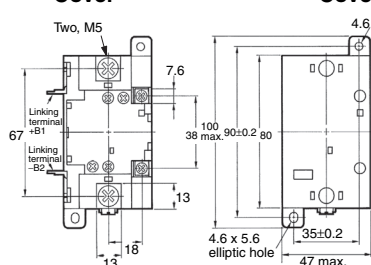

With Terminal Cover

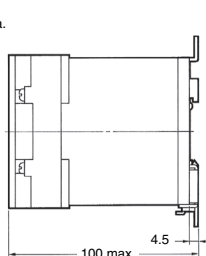

Mounting Holes

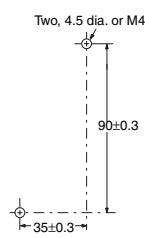

**Terminal Arrangement/
Internal Connections**

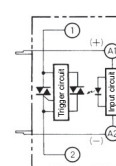

Safety Precautions

■ Precautions for Correct Use

Please observe the following precautions to prevent failure to operate, malfunction, or undesirable effect on product performance.

Load Connection

For an AC load, use a power supply rated at 50 or 60 Hz. The maximum operating frequency is 10 Hz. The G3PA-(VD) has a built-in varistor for overvoltage protection.

At a low applied voltage, such as 24 VAC, the load current is not fully supplied. When the Unit is switched ON, the voltage required to power the Unit deprives the output signal of the necessary voltage level and thus creates loss time. The lower the load voltage is, the greater the loss time is. This condition, however, will not create any serious problems.

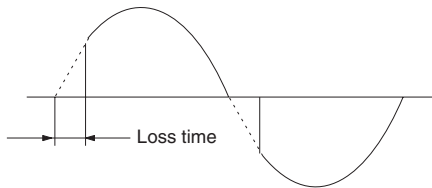

For a DC or L load, a diode should be connected in parallel the load to absorb the counter electromotive force of the load.

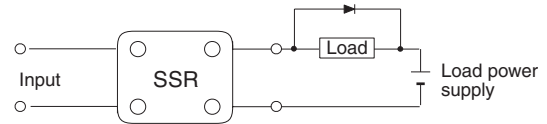

When attaching a heat sink to the G3PA-(VD), in order to facilitate heat dissipation, apply silicone grease or equivalent heat-conductive grease on the heat sink. (Toshiba Silicone, Shinetsu Silicone, etc.)

Tighten the mounting screws of the heat sink with a torque of 0.78 to 0.98 N·m.

Noise Terminal Voltage according to EN55011

The G3PA-(VD) complies with EN55011 standards when a capacitor is connected to the load power supply as shown in the following circuit diagram.

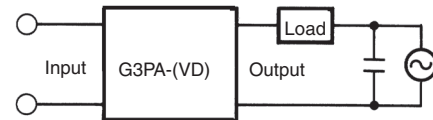

Recommended Capacitor: 1 μF, 250 VAC

Mounting

The rated ambient temperature is 40°C. (30°C for 400 V.)

Vertical mounting

Close mounting

Horizontal mounting

- Screw or DIN track mounting is possible.
- Vertical mounting should usually be used.

- Close mounting cannot be used if the SSR is used at a 100% load current. Leave a gap of at least 10 mm on the left and right of each Unit.
- Close mounting can be used under the following conditions:
 - Close mounting can be performed with no more than three SSRs. (For four or more SSRs, leave a gap of at least 10 mm.)
 - Use a load current of 80% or less (90% or less for the G3PA-210B-VD, G3PA-220B-VD, or G3PA-240B-VD).
 - Leave a gap of at least 80 mm above and below the SSR.
 - Leave a gap of at least 60 mm from wiring ducts to the top of the SSR and at least 30 mm from wiring ducts to the bottom of the SSR.

- With vertical mounting, reduce the load current by 30%. (Refer to the Load Current vs. Ambient Temperature graph.)

Note: Leave a distance of 60 mm min. between SSRs and ducts (especially above the SSR).

Close Mounting

SSR Mounting Pitch

Panel Mounting (At a rated ambient temperature of 40°C).

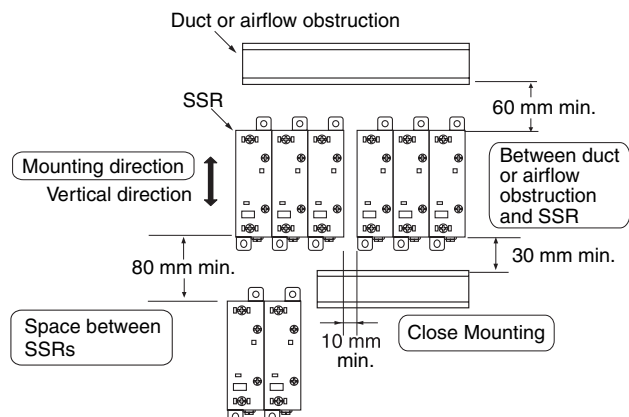

A heat exchanger, if used, should be located in front of the SSR Units to ensure the efficiency of the heat exchanger.

Please reduce the ambient temperature of SSRs.

The rated load current of an SSR is measured at an ambient temperature of 25 or 40 °C.

An SSR uses a semiconductor in the output element. This causes the temperature inside the control panel to increase due to heating resulting from the passage of electrical current through the load. To restrict heating, attach a fan to the ventilation outlet or air inlet of the control panel to ventilate the panel. This will reduce the ambient temperature of the SSRs and thus increase reliability. (Generally, each 10°C reduction in temperature will double the expected life.)

Load current (A)	10 A	20 A	30 A	40 A	60 A
Required number of fans per SSR	0.16	0.31	0.47	0.62	0.93

Example: For 10 SSRs with load currents of 20 A,
 $0.31 \times 10 = 3.1$
 Thus, 4 fans would be required.

Size of fans: 92 mm², Air volume: 0.7 m³/min,
 Ambient temperature of control panel: 30°C

Relationship between SSRs and Ducts

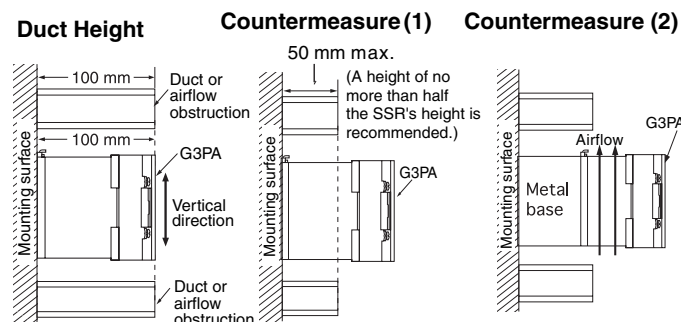

Do not surround the SSR with ducts, otherwise the heat radiation of the SSR will be adversely affected.

Use short ducts.

If the ducts cannot be shortened, place the SSR on a metal base so that it is not surrounded by the ducts.

If there are other instruments that generate heat in the control panel other than SSRs, additional ventilation will be required.

Ventilation

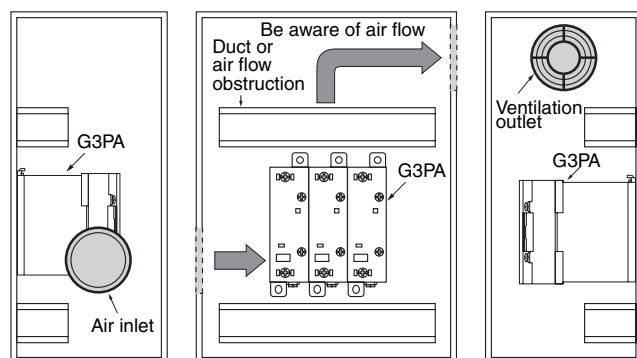

If the air inlet or air outlet has a filter, clean the filter regularly to prevent it from clogging and ensure an efficient flow of air.

Do not locate any objects around the air inlet or air outlet, otherwise the objects may obstruct the proper ventilation of the control panel.

ALL DIMENSIONS SHOWN ARE IN MILLIMETERS.

To convert millimeters into inches, multiply by 0.03937. To convert grams into ounces, multiply by 0.03527.

In the interest of product improvement, specifications are subject to change without notice.

Read and Understand This Catalog

Please read and understand this catalog before purchasing the products. Please consult your OMRON representative if you have any questions or comments.

Warranty and Limitations of Liability

WARRANTY

OMRON's exclusive warranty is that the products are free from defects in materials and workmanship for a period of one year (or other period if specified) from date of sale by OMRON.

OMRON MAKES NO WARRANTY OR REPRESENTATION, EXPRESS OR IMPLIED, REGARDING NON-INFRINGEMENT, MERCHANTABILITY, OR FITNESS FOR PARTICULAR PURPOSE OF THE PRODUCTS. ANY BUYER OR USER ACKNOWLEDGES THAT THE BUYER OR USER ALONE HAS DETERMINED THAT THE PRODUCTS WILL SUITABLY MEET THE REQUIREMENTS OF THEIR INTENDED USE. OMRON DISCLAIMS ALL OTHER WARRANTIES, EXPRESS OR IMPLIED.

LIMITATIONS OF LIABILITY

OMRON SHALL NOT BE RESPONSIBLE FOR SPECIAL, INDIRECT, OR CONSEQUENTIAL DAMAGES, LOSS OF PROFITS OR COMMERCIAL LOSS IN ANY WAY CONNECTED WITH THE PRODUCTS, WHETHER SUCH CLAIM IS BASED ON CONTRACT, WARRANTY, NEGLIGENCE, OR STRICT LIABILITY.

In no event shall the responsibility of OMRON for any act exceed the individual price of the product on which liability is asserted.

IN NO EVENT SHALL OMRON BE RESPONSIBLE FOR WARRANTY, REPAIR, OR OTHER CLAIMS REGARDING THE PRODUCTS UNLESS OMRON'S ANALYSIS CONFIRMS THAT THE PRODUCTS WERE PROPERLY HANDLED, STORED, INSTALLED, AND MAINTAINED AND NOT SUBJECT TO CONTAMINATION, ABUSE, MISUSE, OR INAPPROPRIATE MODIFICATION OR REPAIR.

Application Considerations

SUITABILITY FOR USE

OMRON shall not be responsible for conformity with any standards, codes, or regulations that apply to the combination of products in the customer's application or use of the products.

At the customer's request, OMRON will provide applicable third party certification documents identifying ratings and limitations of use that apply to the products. This information by itself is not sufficient for a complete determination of the suitability of the products in combination with the end product, machine, system, or other application or use.

The following are some examples of applications for which particular attention must be given. This is not intended to be an exhaustive list of all possible uses of the products, nor is it intended to imply that the uses listed may be suitable for the products:

- Outdoor use, uses involving potential chemical contamination or electrical interference, or conditions or uses not described in this catalog.
- Nuclear energy control systems, combustion systems, railroad systems, aviation systems, medical equipment, amusement machines, vehicles, safety equipment, and installations subject to separate industry or government regulations.
- Systems, machines, and equipment that could present a risk to life or property.

Please know and observe all prohibitions of use applicable to the products.

NEVER USE THE PRODUCTS FOR AN APPLICATION INVOLVING SERIOUS RISK TO LIFE OR PROPERTY WITHOUT ENSURING THAT THE SYSTEM AS A WHOLE HAS BEEN DESIGNED TO ADDRESS THE RISKS, AND THAT THE OMRON PRODUCTS ARE PROPERLY RATED AND INSTALLED FOR THE INTENDED USE WITHIN THE OVERALL EQUIPMENT OR SYSTEM.

PROGRAMMABLE PRODUCTS

OMRON shall not be responsible for the user's programming of a programmable product, or any consequence thereof.

Disclaimers

CHANGE IN SPECIFICATIONS

Product specifications and accessories may be changed at any time based on improvements and other reasons.

It is our practice to change model numbers when published ratings or features are changed, or when significant construction changes are made. However, some specifications of the products may be changed without any notice. When in doubt, special model numbers may be assigned to fix or establish key specifications for your application on your request. Please consult with your OMRON representative at any time to confirm actual specifications of purchased products.

DIMENSIONS AND WEIGHTS

Dimensions and weights are nominal and are not to be used for manufacturing purposes, even when tolerances are shown.

PERFORMANCE DATA

Performance data given in this catalog is provided as a guide for the user in determining suitability and does not constitute a warranty. It may represent the result of OMRON's test conditions, and the users must correlate it to actual application requirements. Actual performance is subject to the OMRON Warranty and Limitations of Liability.

ERRORS AND OMISSIONS

The information in this document has been carefully checked and is believed to be accurate; however, no responsibility is assumed for clerical, typographical, or proofreading errors, or omissions.

2008.11

In the interest of product improvement, specifications are subject to change without notice.

OMRON Corporation
Industrial Automation Company

<http://www.ia.omron.com/>

(c)Copyright OMRON Corporation 2008 All Right Reserved.